

PRODUCT INFORMATION
CANNED MOTOR PUMP TYPE CAM / CAMR

REFRIGERATION ENGINEERING

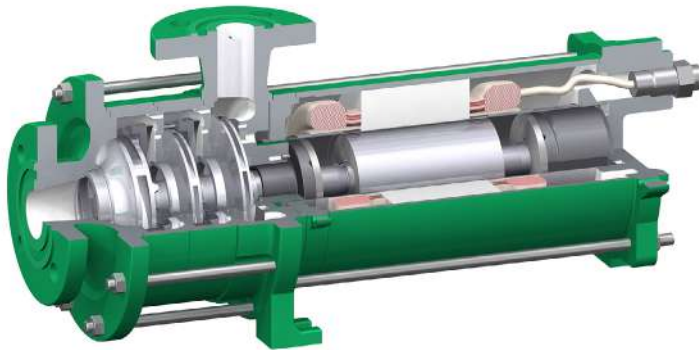

ZART®

simply best balance

Table of Contents

General information	3	CAM 3	17
Pump and hydraulics designations	4	List of parts CAM 3	17
Function	5	Dimension drawing for motors of size: AGX 8.5 / CKPx 12.0 / CKPx 19.0	18
Operating principle	6	Versions CAM 3	19
Bearings	6	Documentation and tests	20
Characteristic maps	7	Installation	21
2900 rpm 50 Hz	7	Protection and monitoring	22
3500 rpm 60 Hz	8	Orifice and inducer	22
Versions	9	Flow regulation	23
Versions CAM / CAMR	9	Flow regulator	23
Materials / pressure stages / flanges	10	Design software	26
CAM 1 / CAM 2	11	Design software / services	26
List of parts CAM 1 / CAM 2	11	Benefits of the design software	27
Dimension drawing for motors of size: AGX 1.0 / AGX 3.0 / AGX 4.5 / AGX 6.5	12	Contact	28
Versions CAM 1	13		
Versions CAM 2	13		
CAMR 2	14		
List of parts CAMR 2	14		
Dimension drawing for motors of size: AGX 3.0 / AGX 4.5 / AGX 6.5	15		
Versions CAMR 2	16		

Table of Contents

General information
Function
Operating principle
Characteristic maps
Versions
CAM 1 / CAM 2
CAMR 2
CAM 3
Documentation and tests
Installation
Protection and monitoring
Flow regulation
Design software
Contact



Information

Applications

- Food industry: Cooling and deep-freezing with natural and synthetic refrigerants
- Sports and leisure facilities, such as: Bobsled tracks, ice rinks or ice hockey stadiums
- Electronics and power converters: modules in mobile (railway) and stationary (offshore wind turbines) applications
- Cooling modules in the chemical industry (optionally in explosion-proof design)
- Freeze-drying and oil-cooling systems for transformers
- CO₂ cooling for mainframes and server centres
- Absorption refrigeration applications with lithium bromide and NH₃

Pumped media

Liquids and liquefied gases, such as NH₃ (R717), CO₂ (R744), R22, R134a, hydrocarbons, R404a, R11, R12, Baysilone (M3, M5), methanol, silicone oil KT3, Syltherm XLT, water glycol mixtures. In principle, the refrigerant pumps are suitable for conveying all types of refrigerant. However, this must be checked for each case.

Type /design

Horizontal, seal-less section-type pumps with completely closed canned motor, with radial impellers, multi-stage, single-flow.

Canned motor pump type CAM

This pump is suitable for conveying liquids near vapour pressure and for standard applications.

Canned motor pump type CAMR

The CAMR pump with radial suction port is particularly suitable for compact systems with small collecting tanks. Due to the degassing on the suction side, the pump is ready for operation sooner after switching off. The pump can be suspended directly under the tank to save space.

Drive

The rotor lining - one of our core competencies - is manufactured by impact extrusion and, as a nickel-based alloy, is an essential component of the highly efficient canned motor. The liquid-filled canned motor accelerates to operating speed within seconds and operates wear-free and maintenance-free in continuous operation due to the hydrodynamic plain bearings. The canned motor is low-noise and low-vibration and offers double security against leakage.

Table of Contents

General information

Function

Operating principle

Characteristic maps

Versions

CAM 1 / CAM 2

CAMR 2

CAM 3

Documentation and tests

Installation

Protection and monitoring

Flow regulation

Design software

Contact



Information

Operating data

Temperature

Areas of application -50 °C to +30 °C

Canned motors

Output	up to 25.0 kW
Speed	2800 rpm or 3500 rpm (frequency control possible – with frequency converter from 1500 rpm to 3500 rpm)
Voltage	230, 400, 480, 500, 575, 690 Volt
Frequency	50 Hz or 60 Hz
Type of protection	IP 55

Pump and hydraulics designations

CAM 2 / 3 AGX 3.0

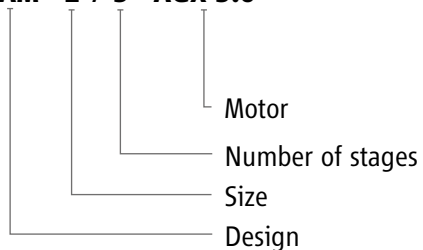

Table of Contents

General information

Function

Operating principle

Characteristic maps

Versions

CAM 1 / CAM 2

CAMR 2

CAM 3

Documentation and tests

Installation

Protection and monitoring

Flow regulation

Design software

Contact



CAM function

The partial flow for cooling the motor and lubricating the bearing is taken from the pressure side after the last impeller and passed through the motor chamber. The partial flow is not returned to the suction side of the pump through the hollow shaft but to an area with increased pressure between two impellers. Therefore, point 3 in the pressure-temperature diagram that corresponds to the greatest heating has sufficient distance from the vapour pressure curve to prevent gasification within the pump.

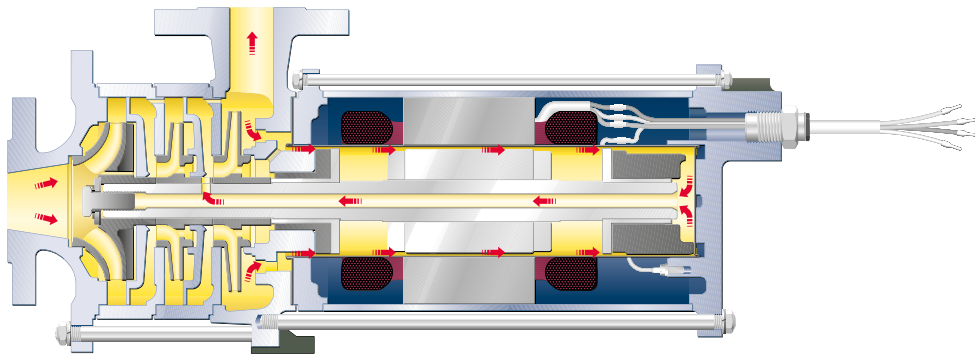

Partial flow return between the stages

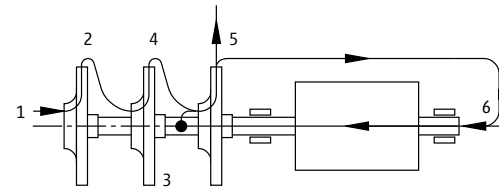

Pressure-temperature diagram

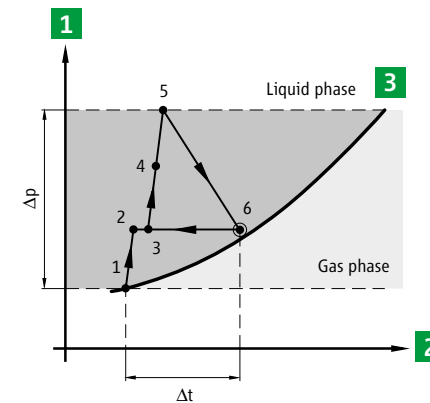

- 1 Pressure
- 2 Temperature
- 3 Vapour pressure curve

Table of Contents

General information

Function

Operating principle

Characteristic maps

Versions

CAM 1 / CAM 2

CAMR 2

CAM 3

Documentation and tests

Installation

Protection and monitoring

Flow regulation

Design software

Contact



Bearings

The hermetically sealed design requires the arrangement of bearings in the pumped liquid. Therefore, only hydrodynamic plain bearings are used in HERMETIC pumps. With correct operational mode, these bearings have the advantage that there is no contact between the bearing sliding surfaces. As a result, they are wear-free and maintenance-free in continuous operation. A service life of 20 years is common for hermetically sealed pumps.

In refrigeration engineering, carbon graphite is used as the bearing bush material that can withstand particularly high radial and axial loads. In addition, the material has a high resistance to elevated and low temperatures and high fatigue strength.



Table of Contents

General information

Function

Operating principle

Characteristic maps

Versions

CAM 1 / CAM 2

CAMR 2

CAM 3

Documentation and tests

Installation

Protection and monitoring

Flow regulation

Design software

Contact



2900 rpm 50 Hz

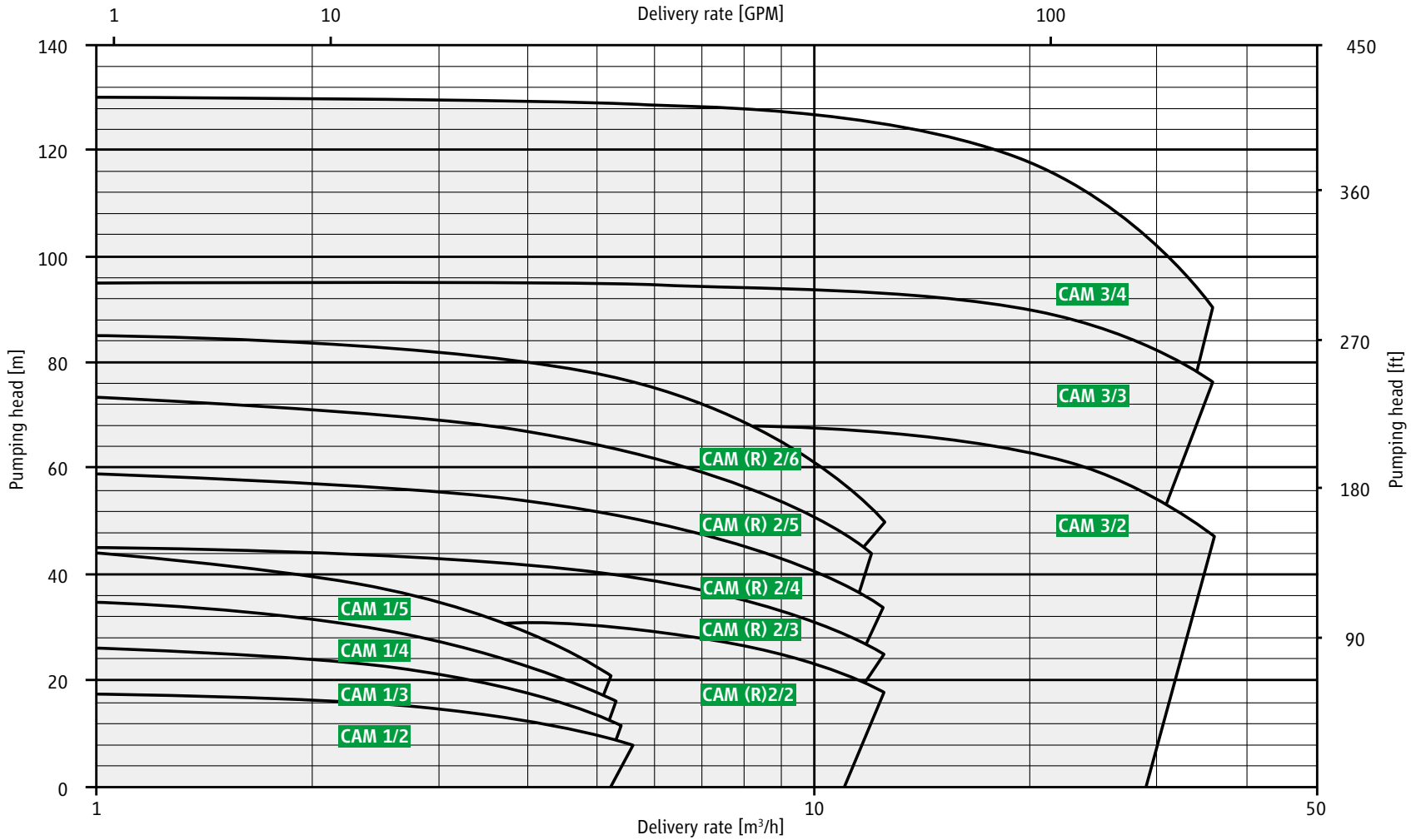

- Table of Contents
- General information
- Function
- Operating principle
- Characteristic maps**
- Versions
- CAM 1 / CAM 2
- CAM R 2
- CAM 3
- Documentation and tests
- Installation
- Protection and monitoring
- Flow regulation
- Design software
- Contact



3500 rpm 60 Hz

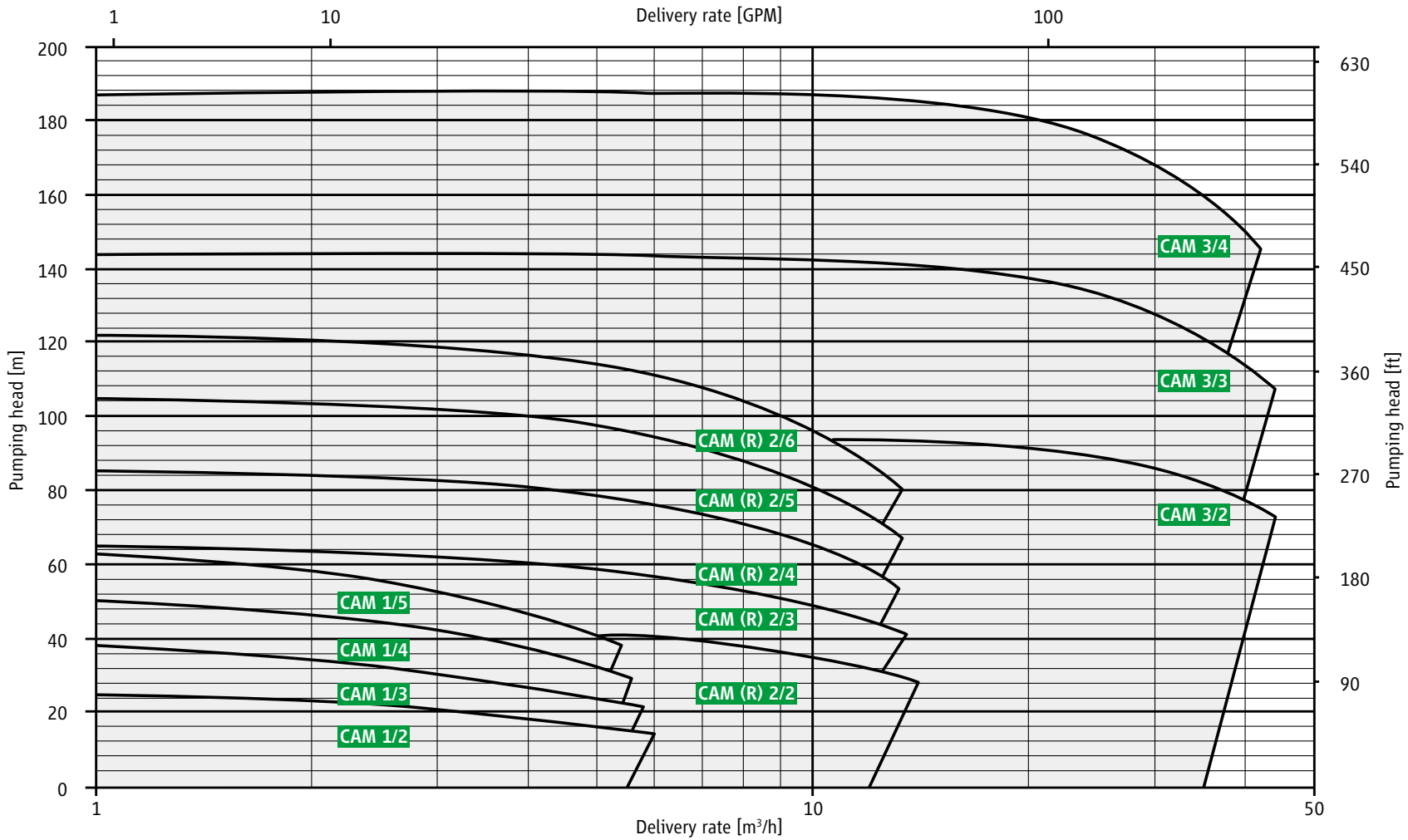

- Table of Contents
- General information
- Function
- Operating principle
- Characteristic maps**
- Versions
- CAM 1 / CAM 2
- CAM R 2
- CAM 3
- Documentation and tests
- Installation
- Protection and monitoring
- Flow regulation
- Design software
- Contact



Versions CAM / CAMR

Type	Motor	Pump data		Motor data 50 Hz / 60 Hz		Weight kg	PN
		Q _{min} m ³ /h	Q _{max} m ³ /h	Output kW [P2]	Rated current at 400 V / 480 V		
CAM 1/2	AGX 1.0	0.5	5.0	1.0 / 1.2	2.7	27.0	40
CAM 1/3	AGX 1.0	0.5	5.0	1.0 / 1.2	2.7	28.0	40
CAM 1/4	AGX 1.0	0.5	5.0	1.0 / 1.2	2.7	29.0	40
CAM 1/5	AGX 1.0	0.5	5.0	1.0 / 1.2	2.7	30.0	40
CAM (R) 2/2	AGX 3.0	1.0	13.0	3.0 / 3.4	7.1	48.0	40
CAM (R) 2/2	AGX 4.5	1.0	14.0	4.5 / 5.6	10.4	56.0	40
CAM (R) 2/3	AGX 3.0	1.0	13.0	3.0 / 3.4	7.1	52.0	40
CAM (R) 2/3	AGX 4.5	1.0	14.0	4.5 / 5.6	10.4	60.0	40
CAM (R) 2/3	AGX 6.5	1.0	14.0	6.5 / 7.5	15.2	63.0	40
CAM (R) 2/4	AGX 3.0	1.0	14.0	3.0 / 3.4	7.1	56.0	40
CAM (R) 2/4	AGX 4.5	1.0	14.0	4.5 / 5.6	10.4	68.0	40
CAM (R) 2/4	AGX 6.5	1.0	14.0	6.5 / 7.5	15.2	71.0	40
CAM (R) 2/5	AGX 3.0	1.0	14.0	3.0 / 3.4	7.1	60.0	40
CAM (R) 2/5	AGX 4.5	1.0	14.0	4.5 / 5.6	10.4	74.0	40
CAM (R) 2/5	AGX 6.5	1.0	14.0	6.5 / 7.5	15.2	77.0	40
CAM (R) 2/6	AGX 3.0	1.0	14.0	3.0 / 3.4	7.1	64.0	40
CAM (R) 2/6	AGX 4.5	1.0	14.0	4.5 / 5.6	10.4	78.0	40
CAM (R) 2/6	AGX 6.5	1.0	14.0	6.5 / 7.5	15.2	81.0	40
CAM 3/2	AGX 8.5	6.0	30.0	8.5 / 9.7	19.0	120.0	40
CAM 3/2	CKPx 12.0	6.0	30.0	13.5 / 15.7	31.0	150.0	25 / 40
CAM 3/3	AGX 8.5	6.0	30.0	8.5 / 9.7	19.0	138.0	40
CAM 3/3	CKPx 12.0	6.0	30.0	13.5 / 15.7	31.0	168.0	25 / 40
CAM 3/3	CKPx 19.0	6.0	30.0	22.0 / 25.0	49.5	213.0	25 / 40
CAM 3/4	CKPx 12.0	6.0	35.0	13.5 / 15.7	31.0	186.0	25 / 40
CAM 3/4	CKPx 19.0	6.0	35.0	22.0 / 25.0	49.5	231.0	25 / 40

Table of Contents

General information

Function

Operating principle

Characteristic maps

Versions

CAM 1 / CAM 2

CAMR 2

CAM 3

Documentation and tests

Installation

Protection and monitoring

Flow regulation

Design software

Contact



Materials / pressure stages / flanges

Housing	JS 1025
Suction cover (suction housing CAMR 2)	JS 1025
Stage casing (CAM 1, CAM 2, CAMR 2)	1.0460
Stage casing (CAM 3)	JS 1025
Diffuser (guide wheel CAM 3)	JL 1030
Impellers	JL 1030
Slide bearing	1.4021 / carbon
Shaft	1.4021
Rotor lining	1.4571
Seals	AFM 34*
Pressure rating	PN 40**, PN 25 (for motors CKPx 12.0 and CKPx 19.0)
Flanges	according to DIN EN 1092-1, PN 40 and PN 25 type D

* asbestos-free aramid fibre, ** test pressure 60 bar

Noise expectancy values

Motors	AGX 1.0	AGX 3.0	AGX 4.5	AGX 6.5	AGX 8.5	CKPx 12.0	CKPx 19.0
Output power [P2 at 50 Hz]	1.0 kW	3.0 kW	4.5 kW	6.5 kW	8.5 kW	13.5 kW	22.0 kW
max. expected sound pressure level dB(A) at 50 Hz	48	52	54	56	57	59	61
Output power [P2 at 60 Hz]	1.2 kW	3.4 kW	5.6 kW	7.5 kW	9.7 kW	15.7 kW	25.0 kW
max. expected sound pressure level dB(A) at 60 Hz	48	52	55	56	57	59	61

Table of Contents

General information

Function

Operating principle

Characteristic maps

Versions

CAM 1 / CAM 2

CAMR 2

CAM 3

Documentation and tests

Installation

Protection and monitoring

Flow regulation

Design software

Contact



List of parts CAM 1 / CAM 2

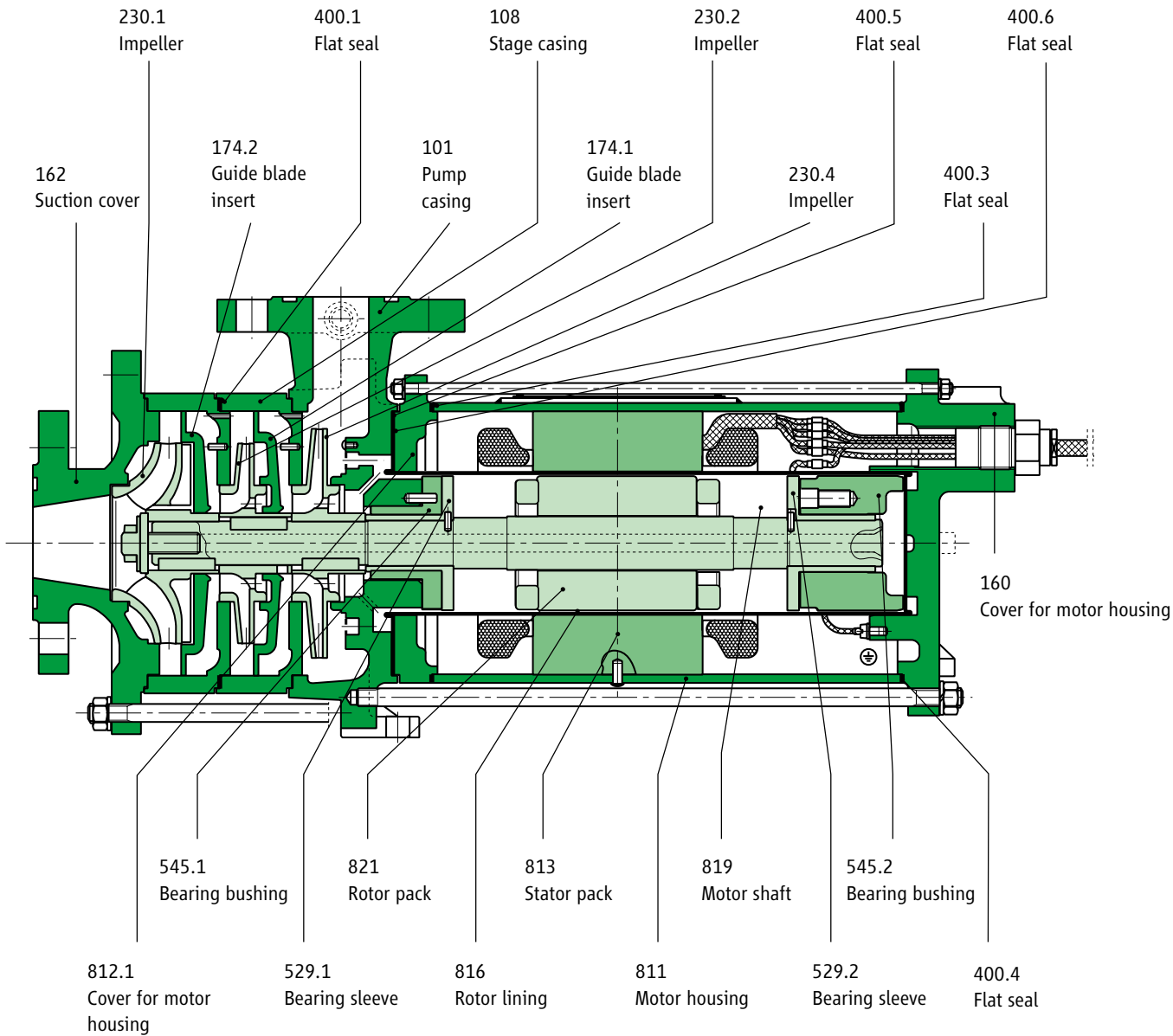

- Table of Contents
- General information
- Function
- Operating principle
- Characteristic maps
- Versions
- CAM 1 / CAM 2**
- CAMR 2
- CAM 3
- Documentation and tests
- Installation
- Protection and monitoring
- Flow regulation
- Design software
- Contact

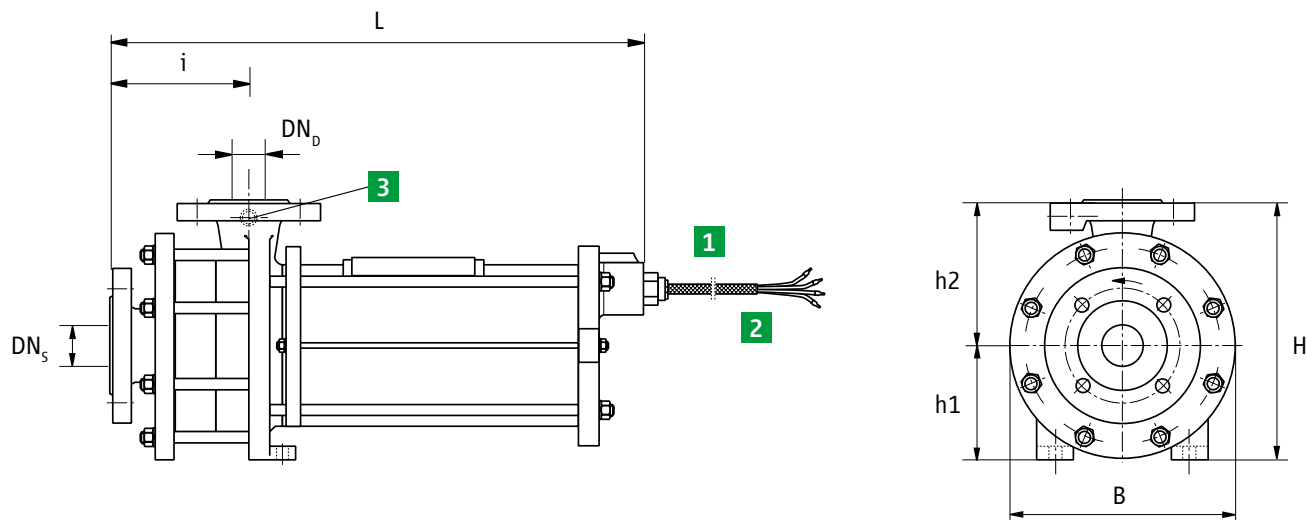

Dimension drawing for motors of size: AGX 1.0 / AGX 3.0 / AGX 4.5 / AGX 6.5

- | | |
|---|--|
| 1 Cable U1, V1, W1 + protective conductor \oplus | 2 Cable for PTC thermistor |
| AGX 1.0: 4 x 1.5 mm ² | 2 x 1.0 mm ² , cable 5 + 6, |
| AGX 3.0: 4 x 1.5 mm ² | Cable length 2.5 m |
| AGX 4.5: 4 x 2.5 mm ² | 3 Pressure gauge connection G 1/4 |
| AGX 6.5: 4 x 4 mm ² | |
| Cable length 2.5 m | |

[Table of Contents](#)
[General information](#)
[Function](#)
[Operating principle](#)
[Characteristic maps](#)
[Versions](#)
[CAM 1 / CAM 2](#)
[CAMR 2](#)
[CAM 3](#)
[Documentation and tests](#)
[Installation](#)
[Protection and monitoring](#)
[Flow regulation](#)
[Design software](#)
[Contact](#)

Versions CAM 1

Dimensions	CAM 1 / 2-stage	CAM 1 / 3-stage	CAM 1 / 4-stage	CAM 1 / 5-stage
	AGX 1.0	AGX 1.0	AGX 1.0	AGX 1.0
Length / L	419	447	475	503
Width / W	160	160	160	160
Height / H	10	210	210	210
h1	90	90	90	90
h2	120	120	120	120
i	112	140	168	196
DN _s	25	25	25	25
DN _b	20	20	20	20

Versions CAM 2

Dimensions	CAM 2 / 2-stage	CAM 2 / 3-stage	CAM 2 / 4-stage	CAM 2 / 5-stage	CAM 2 / 6-stage
	AGX 3.0 / 4.5	AGX 3.0 to 6.5	AGX 3.0 to 6.5	AGX 3.0 to 6.5	AGX 3.0 to 6.5
Length / L	536	577	618	659	700
Width / W	218	218	218	218	218
Height / H	250	250	250	250	250
h1	110	110	110	110	110
h2	140	140	140	140	140
i	135	176	217	258	299
DN _s	40	40	40	40	40
DN _b	32	32	32	32	32

Table of Contents

General information

Function

Operating principle

Characteristic maps

Versions

CAM 1 / CAM 2

CAMR 2

CAM 3

Documentation and tests

Installation

Protection and monitoring

Flow regulation

Design software

Contact



List of parts CAMR 2

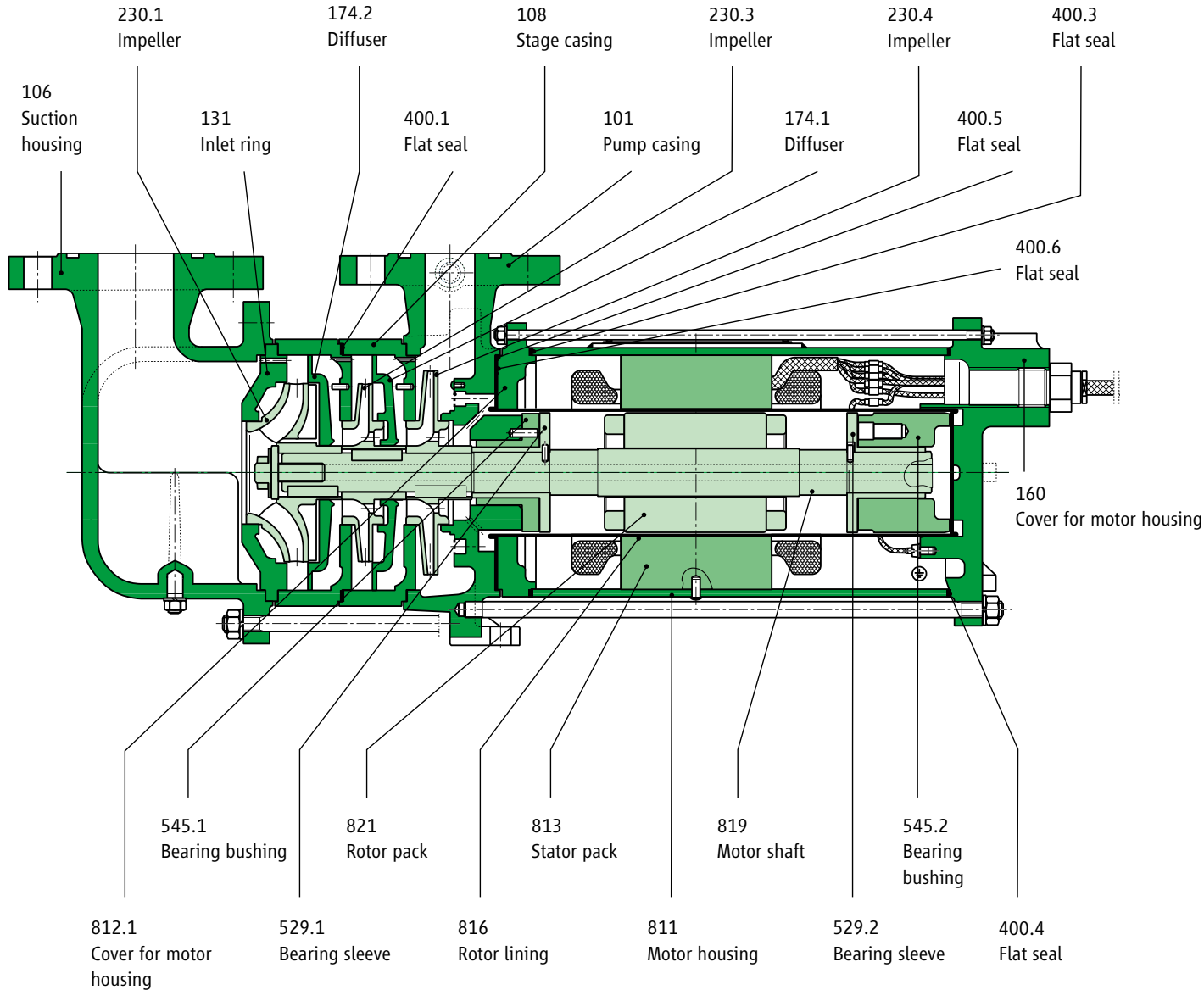

- Table of Contents
- General information
- Function
- Operating principle
- Characteristic maps
- Versions
- CAM 1 / CAM 2
- CAMR 2**
- CAM 3
- Documentation and tests
- Installation
- Protection and monitoring
- Flow regulation
- Design software
- Contact



Dimension drawing for motors of size: AGX 3.0 / AGX 4.5 / AGX 6.5

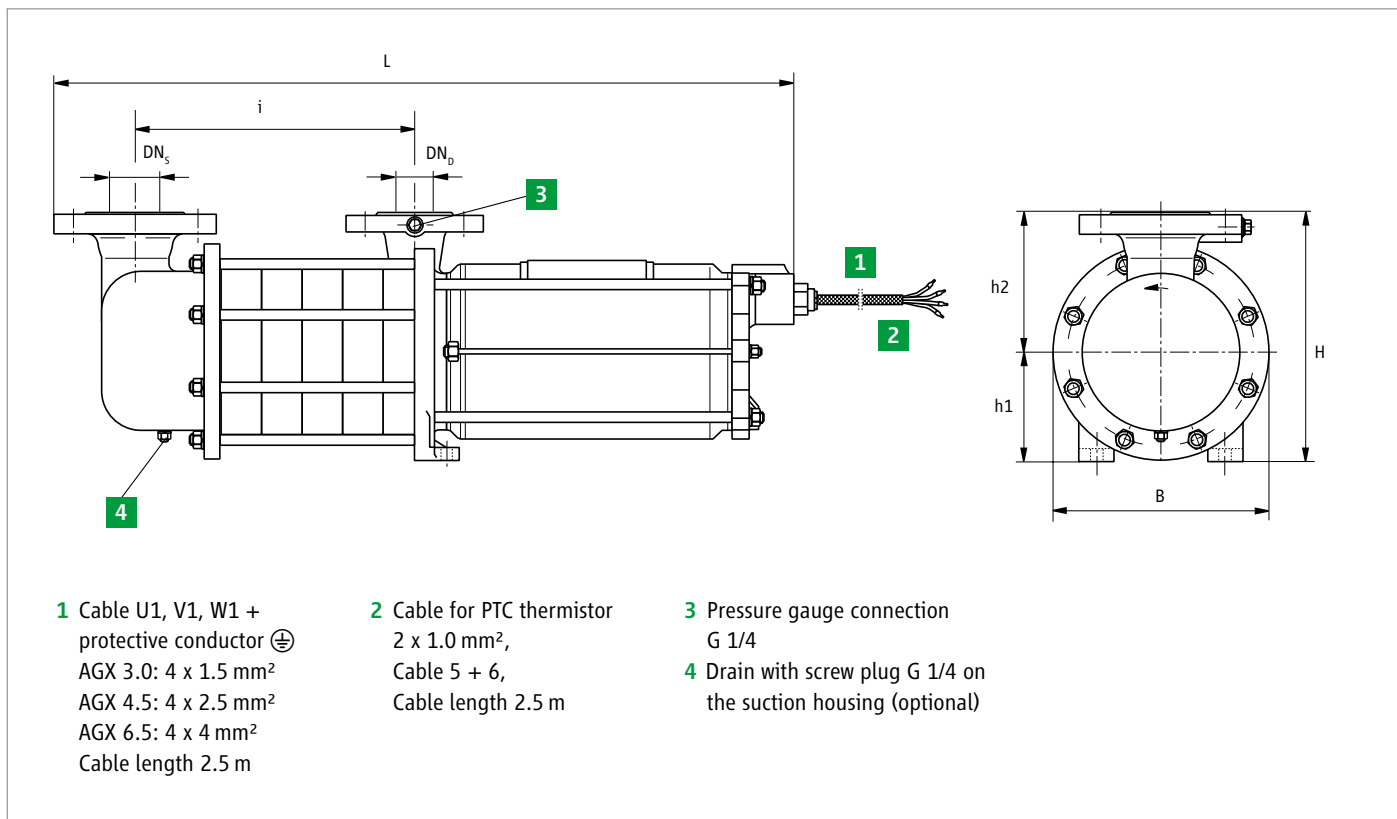

Table of Contents

General information

Function

Operating principle

Characteristic maps

Versions

CAM 1 / CAM 2

CAMR 2

CAM 3

Documentation and tests

Installation

Protection and monitoring

Flow regulation

Design software

Contact



Versions CAMR 2

Dimensions	CAMR 2 / 2-stage	CAMR 2 / 3-stage	CAMR 2 / 4-stage	CAMR 2 / 5-stage	CAMR 2 / 6-stage
	AGX 3.0 / 4.5	AGX 3.0 to 6.5	AGX 3.0 to 6.5	AGX 3.0 to 6.5	AGX 3.0 to 6.5
Length / L	649	690	731	772	813
Width / W	218	218	218	218	218
Height / H	250	250	250	250	250
h1	110	110	110	110	110
h2	140	140	140	140	140
i	160	201	242	283	324
DN _s	50	50	50	50	50
DN _b	32	32	32	32	32

Table of Contents

General information

Function

Operating principle

Characteristic maps

Versions

CAM 1 / CAM 2

CAMR 2

CAM 3

Documentation and tests

Installation

Protection and monitoring

Flow regulation

Design software

Contact

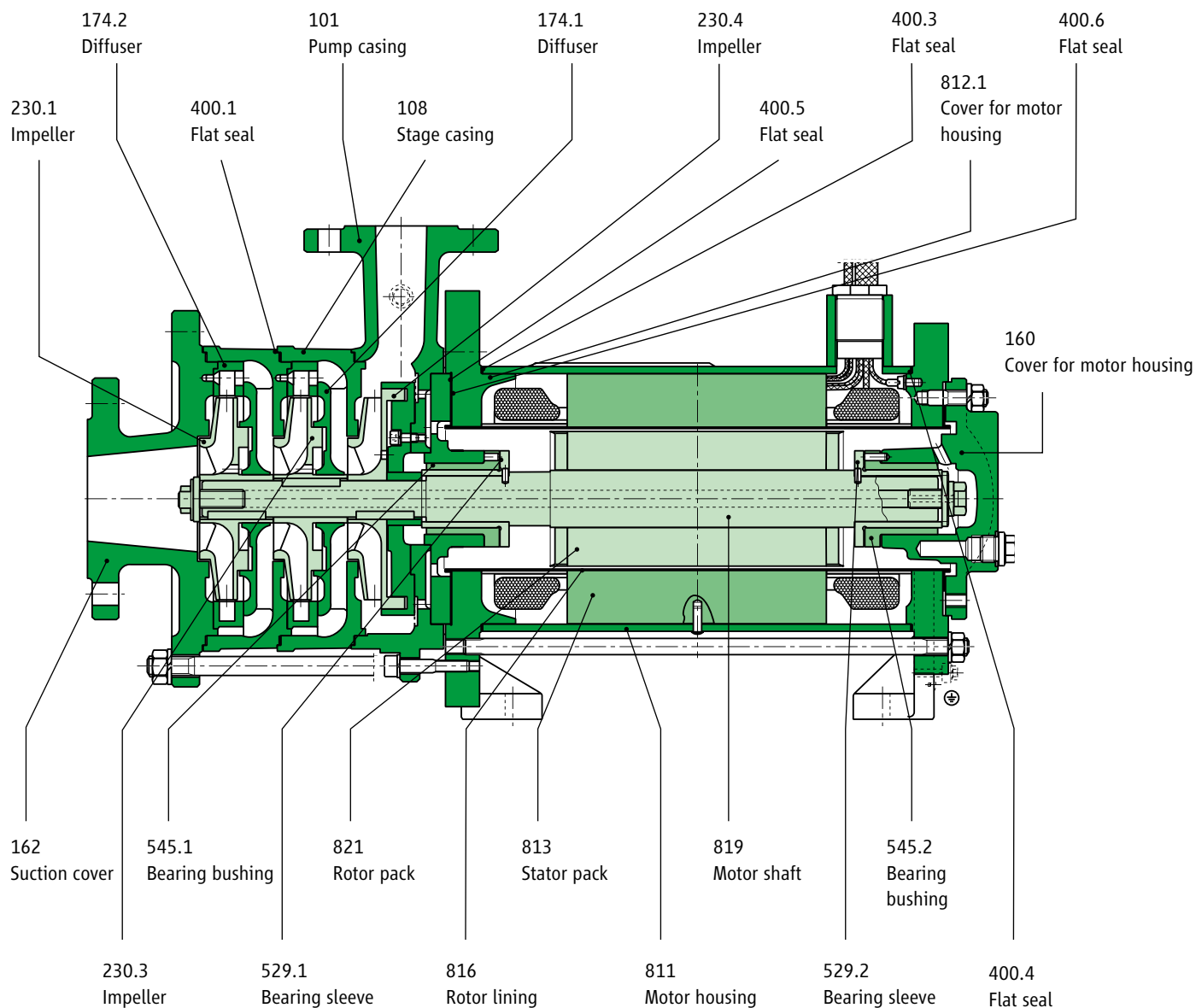

List of parts CAM 3

[Table of Contents](#)
[General information](#)
[Function](#)
[Operating principle](#)
[Characteristic maps](#)
[Versions](#)
[CAM 1 / CAM 2](#)
[CAMR 2](#)
[CAM 3](#)
[Documentation and tests](#)
[Installation](#)
[Protection and monitoring](#)
[Flow regulation](#)
[Design software](#)
[Contact](#)

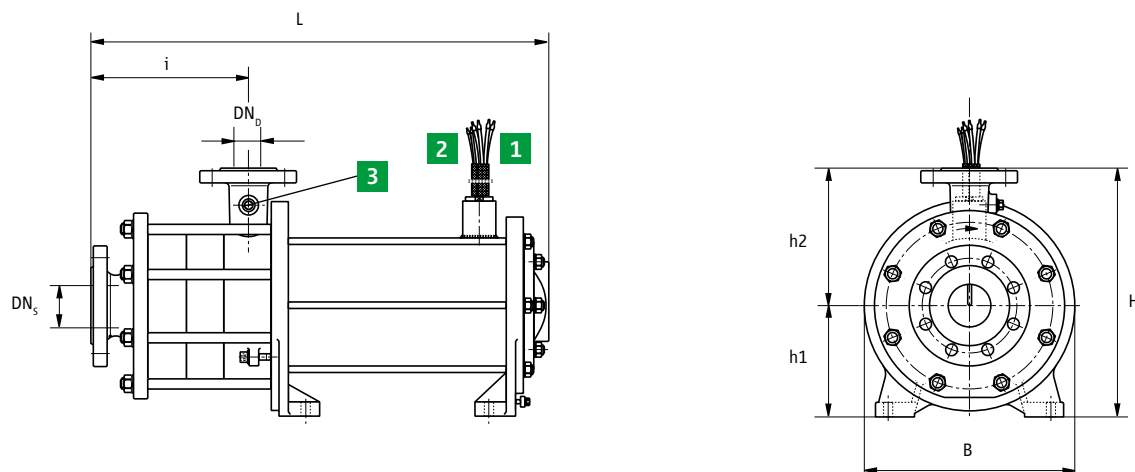
Dimension drawing for motors of size: AGX 8.5 / CKPx 12.0 / CKPx 19.0

- | | |
|--|--|
| <p>1 Cable U1, V1, W1 + protective conductor ⊕
 AGX 8.5: 4 x 6 mm²
 CKPx 12.0: 4 x 6 mm²
 CKPx 19.0: 4 x 6 mm²
 Cable length 2.5 m</p> | <p>2 Cable for PTC thermistor
 2 x 1.0 mm², cable 5 + 6,
 Cable length 2.5 m</p> <p>3 Pressure gauge connection G 1/4</p> |
|--|--|

[Table of Contents](#)
[General information](#)
[Function](#)
[Operating principle](#)
[Characteristic maps](#)
[Versions](#)
[CAM 1 / CAM 2](#)
[CAMR 2](#)
[CAM 3](#)
[Documentation and tests](#)
[Installation](#)
[Protection and monitoring](#)
[Flow regulation](#)
[Design software](#)
[Contact](#)

Versions CAM 3

Dimensions	CAM 3 / 2-stage	CAM 3 / 2-stage	CAM 3 / 3-stage	CAM 3 / 3-stage	CAM 3 / 3-stage	CAM 3 / 4-stage	CAM 3 / 4-stage
	AGX 8.5	CKPx 12.0	AGX 8.5	CKPx 12.0	CKPx 19.0	CKPx 12.0	CKPx 19.0
Length / L	597	642	654	699	764	756	821
Width / W	250	290	250	290	340	290	340
Height / H	355	380	355	380	380	380	380
h1	145	170	145	170	170	170	170
h2	210	210	210	210	210	210	210
i	184	184	241	241	241	298	298
DN _s	65	65	65	65	65	65	65
DN _d	40	40	40	40	40	40	40

Table of Contents

General information

Function

Operating principle

Characteristic maps

Versions

CAM 1 / CAM 2

CAMR 2

CAM 3

Documentation and tests

Installation

Protection and monitoring

Flow regulation

Design software

Contact



Documentation and tests

Documentation according to HERMETIC Standard consisting of:

Operating manual for the HERMETIC pump

Technical specifications

Characteristic curve of the pump

Sectional drawing

Bills of materials

Dimensional drawing

Cable connection diagram

Plain bearing play

EU Declaration of Conformity

Warranty

30 months from delivery

Standard tests

Hydrostatic pressure test with 1.5x nominal pressure

Balancing of shaft and impeller according to DIN ISO 1940, 6.3

Leak test of the complete pump

Functional test (optionally with protocol)

Additional test

Factory certificate according to EN 10204 / 3.1 for pressurised parts in contact with medium (chemical analysis)

Factory certificate according to EN 10204 / 3.1 for counter flanges

Factory certificate according to EN 10204 / 2.2 for impeller and pump shaft

EUR.1 movement certificate (after examination)

RMRS / DNV / Hapag Lloyd

Table of Contents

General information

Function

Operating principle

Characteristic maps

Versions

CAM 1 / CAM 2

CAMR 2

CAM 3

Documentation and tests

Installation

Protection and monitoring

Flow regulation

Design software

Contact



Automatic venting

1. Use a non-return valve between the discharge nozzle and gate valve to ensure that the medium does not flow back after switching off the pump.
2. To allow venting, provide a bypass pipe:
 - Ahead of the non-return valve.
 - Please note: do not provide non-return valves in the bypass pipe.
3. For parallel operation:
 - Separate supplies for the pumps
 - Separate bypass pipes

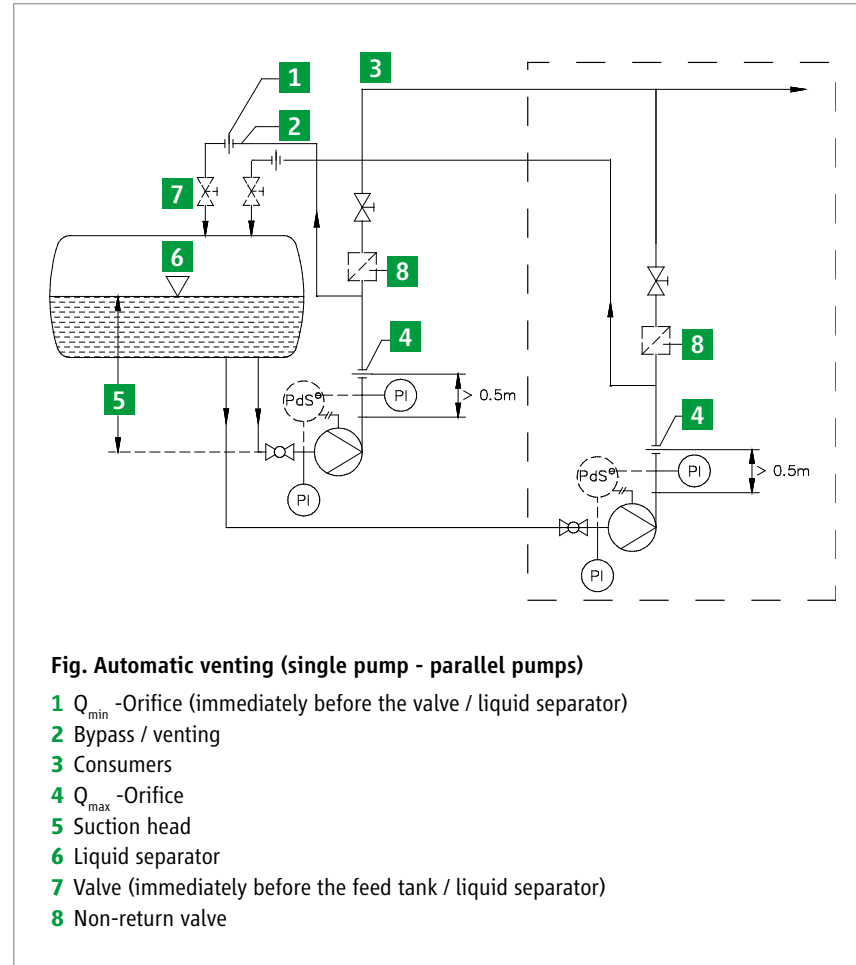

Table of Contents

General information

Function

Operating principle

Characteristic maps

Versions

CAM 1 / CAM 2

CAMR 2

CAM 3

Documentation and tests

Installation

Protection and monitoring

Flow regulation

Design software

Contact



Orifice and inducer

Orifice

We recommend protecting the HERMETIC pumps by using two orifices against any outside influence (for example by operating personnel). Orifice 1 (Q_{\min}) ensures the minimum throughput required to dissipate the motor heat loss. Orifice 2 (Q_{\max}) maintains the minimum differential pressure in the rotor space that is needed to stabilise the hydraulic axial thrust balancing and to prevent the evaporation of the partial flow. A flow regulator can be used instead of the Q_{\max} orifice.

Inducer

Inducers are axial impellers that are arranged on the same shaft immediately in front of the first impeller of a centrifugal pump to generate an additional static pressure in front of the blade cascade of the impeller. Inducers are primarily used where the energy level provided by the system is insufficient ($NPSHA > NPSHR$). The HERMETIC inducer reduces the NPSHR value of the pump by approx. 0.5 m over the entire characteristic curve. In many cases, inducers are also used prophylactically if the expected resistance of the inlet or suction line cannot be accurately determined or if fluctuations in NPSHA are expected due to changes in the geodetic height of the inlet liquid level or its pressure superimposition. Inducers are also particularly suitable for conveying boiling liquids (that are afflicted with gas bubbles). In both cases, the inducer can be used to prevent cavitation or reduced output provided it is correctly calculated and matches the flow rate of the impeller it feeds.

Table of Contents

General information

Function

Operating principle

Characteristic maps

Versions

CAM 1 / CAM 2

CAMR 2

CAM 3

Documentation and tests

Installation

Protection and monitoring

Flow regulation

Design software

Contact



Flow regulator

General information

The flow regulator was specially developed for refrigerant systems. This type of valve allows the safe operation of pumps in a range normally not possible for pumps with Q_{max} orifice. The adjacent graph shows the added operating range obtained by using a flow regulator instead of a Q_{max} orifice. Often, a smaller, less expensive pump can be used.

Operation

The flow regulator must be filled with liquid during operation. The operation of the valve depends on the material data of the pumped medium. When ordering the valve, it is therefore important that complete information on the characteristics of the pumped medium in the operating range to be regulated is available. The density of the pumped medium is the most important characteristic for the correct design of a valve.

Maintenance

The flow regulator requires no regular maintenance or readjustment. The valve inserts can be reordered if necessary.

Area of application

The flow regulator is mounted on the discharge branch of the pump. The flow regulator limits the maximum flow rate of the pump. However, in contrast to the Q_{max} orifice, the flow rate $< Q_{max}$ is almost equal to the full delivery pressure of the pump behind the valve. The flow regulator regulates the delivery rate to ensure that the maximum pump capacity is not exceeded. This protects the pump from overload and keeps the delivery rate within the optimum NPSH range of the pump.

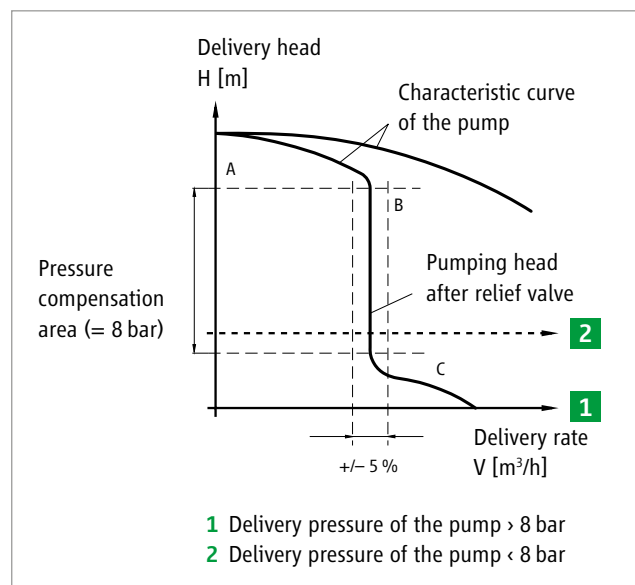

Table of Contents

General information

Function

Operating principle

Characteristic maps

Versions

CAM 1 / CAM 2

CAMR 2

CAM 3

Documentation and tests

Installation

Protection and monitoring

Flow regulation

Design software

Contact



Flow regulator

Working principle

The flow restriction is achieved by specially shaped openings in a spring-loaded, movable piston. The pressure difference in front of and behind the piston moves it. This ensures that only the appropriate amount flows through the openings. It follows that with increasing pressure difference, the spring is compressed. This means that the specially shaped openings are only partially released. When the pressure difference in front of and behind the valve decreases, the spring pushes the piston back in line with the changing pressure difference releasing a larger part of the opening. If the pressure difference exceeds the specified maximum value (pressure compensation range, generally 8 bar), the spring is compressed up to the stop, and the valve then works like a fixed orifice. The same applies when the required minimum pressure is not reached.

Functional schematic of the valve

Position A

In position A, the insert works as an orifice. As a result, little pressure is relieved at the valve.

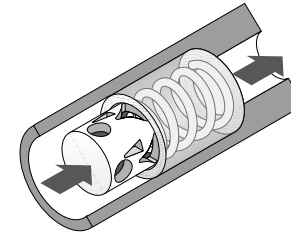

Position B

In the pressure compensation range, the insert limits the maximum volumetric flow rate as a function of the differential pressure with an accuracy of $\pm 5\%$.

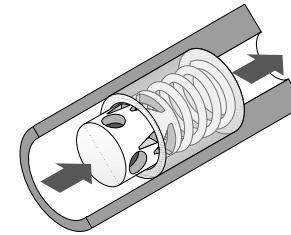

Position C

Behind the pressure compensation area, the insert is completely compressed and acts as an orifice.

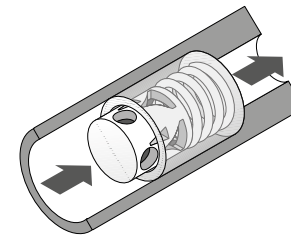

Table of Contents

General information

Function

Operating principle

Characteristic maps

Versions

CAM 1 / CAM 2

CAMR 2

CAM 3

Documentation and tests

Installation

Protection and monitoring

Flow regulation

Design software

Contact



Flow regulator

The valve is available for the following flow rates

Model	Pressure rating	NW	max. flow rate for H ₂ O
32-40-40-10	40 bar	32	10,00 m ³ /h
40-40-80-19	40 bar	40	19,30 m ³ /h
40-40-80-25	40 bar	40	25,00 m ³ /h
40-40-80-34	40 bar	40	34,10 m ³ /h
50-40-80-25	40 bar	50	25,00 m ³ /h
50-40-80-34	40 bar	50	34,10 m ³ /h

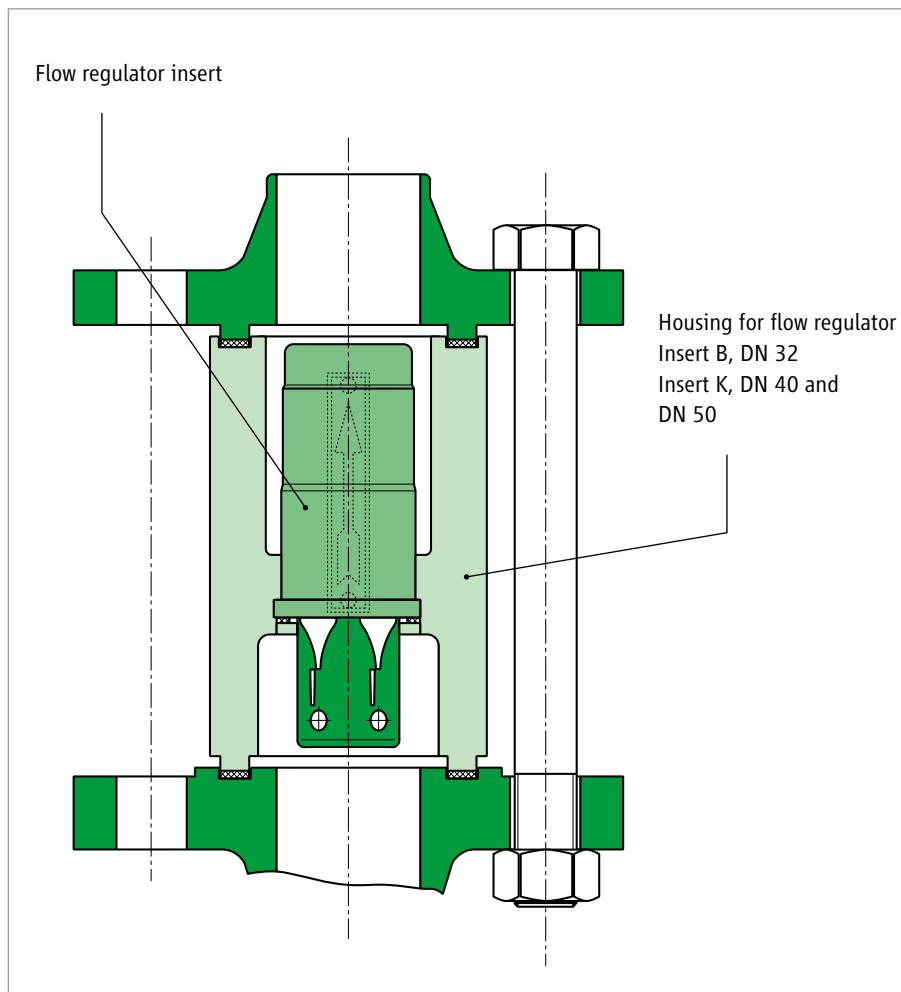

- Table of Contents
- General information
- Function
- Operating principle
- Characteristic maps
- Versions
- CAM 1 / CAM 2
- CAMR 2
- CAM 3
- Documentation and tests
- Installation
- Protection and monitoring
- Flow regulation**
- Design software
- Contact

Design software / services

Online design

The user-oriented design software simplifies the selection of the right refrigerant pump. It is also possible to calculate the energy-saving options with the software. The software-based design for frequency-controlled operation is easily possible. Minimum and maximum speeds and the appropriate operating range are displayed.

Quick registration

Do you want to know more about the many benefits of our new design software?

Simply register as a new user on our homepage www.hermetic-pumpen.com

After registration and receiving the access data, you can test the design software free of charge. Registered users simply log in using their access data – a new registration is not required.

Other online services

We provide free 3D CAD models for your planning and your design office.

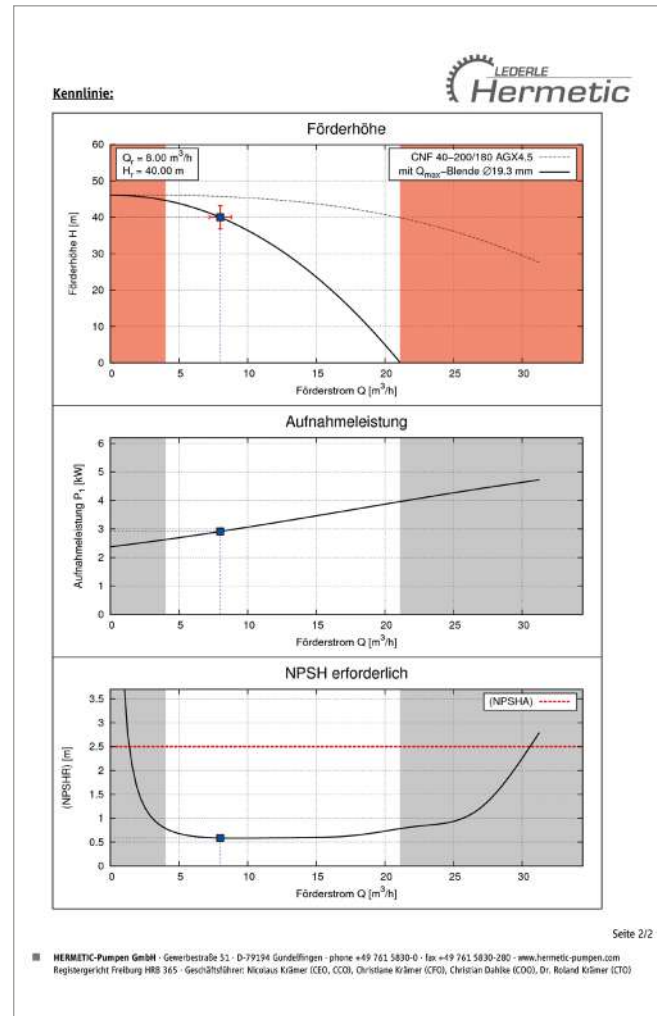

Example view after pump selection

Table of Contents

General information

Function

Operating principle

Characteristic maps

Versions

CAM 1 / CAM 2

CAMR 2

CAM 3

Documentation and tests

Installation

Protection and monitoring

Flow regulation

Design software

Contact



Benefits of the design software

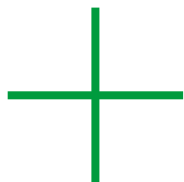

Direct entry of the required refrigeration capacity

Dynamic selection according to power consumption, NPSH

The database contains all common refrigerants

Integration of different pump protection systems, such as Q_{\max} orifice or flow regulator

Design for variable-speed drives

Table of Contents

General information

Function

Operating principle

Characteristic maps

Versions

CAM 1 / CAM 2

CAMR 2

CAM 3

Documentation and tests

Installation

Protection and monitoring

Flow regulation

Design software

Contact



PRODUCT INFORMATION

Contact

sales-support@hermetic-pumpen.com

www.hermetic-pumpen.com

YouTube | LinkedIn | Expert tool

- Table of Contents
- General information
- Function
- Operating principle
- Characteristic maps
- Versions
 - CAM 1 / CAM 2
 - CAMR 2
 - CAM 3
- Documentation and tests
- Installation
- Protection and monitoring
- Flow regulation
- Design software
- Contact**

