



# Lowara® 1300 Series: Pure performance

SUBMERSIBLE PUMP RANGE

CAPACITIES UP TO	414 m <sup>3</sup> /h
HEAD UP TO	63 m
POWER UP TO	18 kW

 **LOWARA**  
a xylem brand

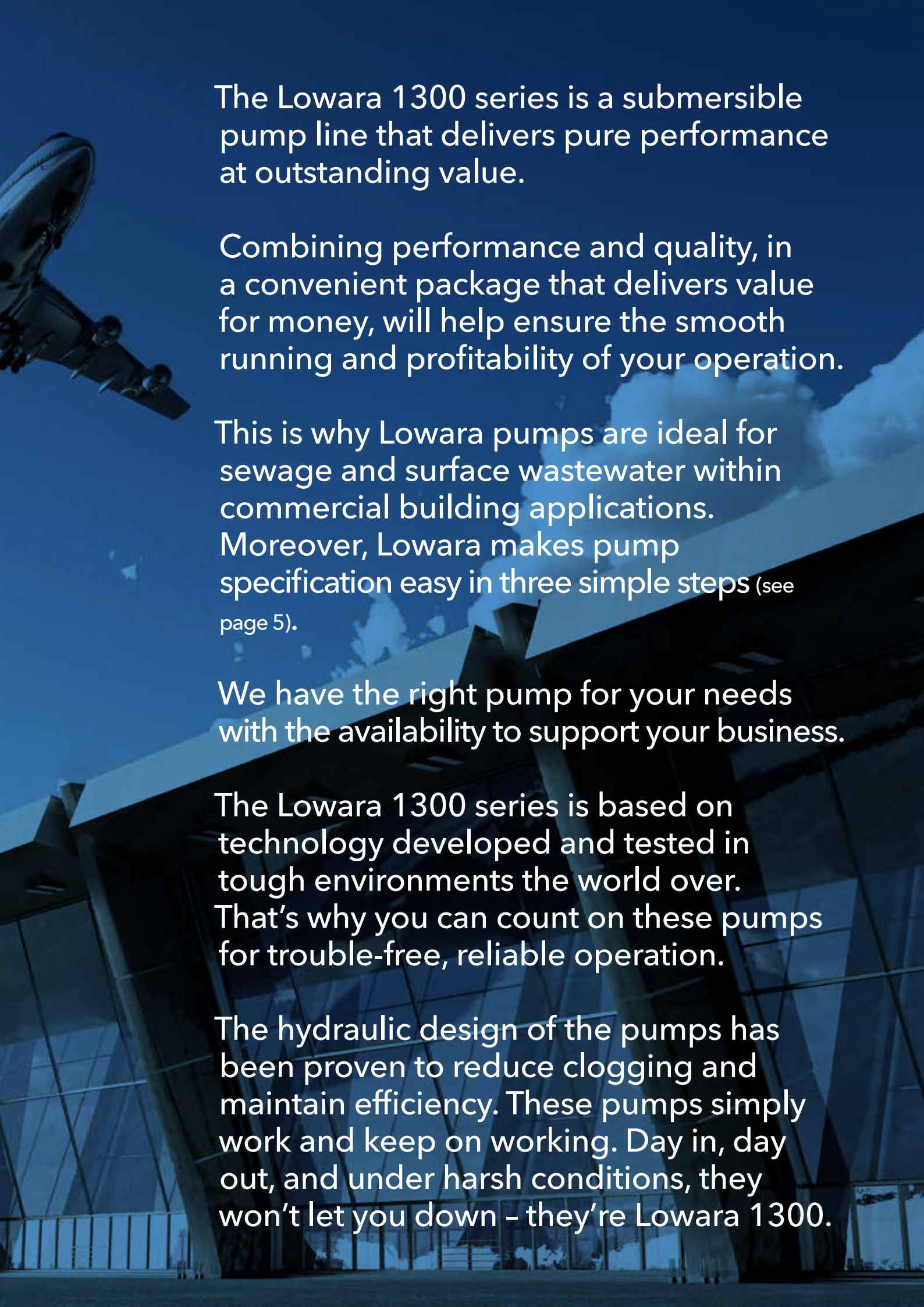

The Lowara 1300 series is a submersible pump line that delivers pure performance at outstanding value.

Combining performance and quality, in a convenient package that delivers value for money, will help ensure the smooth running and profitability of your operation.

This is why Lowara pumps are ideal for sewage and surface wastewater within commercial building applications. Moreover, Lowara makes pump specification easy in three simple steps (see page 5).

We have the right pump for your needs with the availability to support your business.

The Lowara 1300 series is based on technology developed and tested in tough environments the world over. That's why you can count on these pumps for trouble-free, reliable operation.

The hydraulic design of the pumps has been proven to reduce clogging and maintain efficiency. These pumps simply work and keep on working. Day in, day out, and under harsh conditions, they won't let you down - they're Lowara 1300.

# Lowara® 1300:

## Available

## Value for money

## Reliable

With a variety of combinations of non-clog and vortex impellers to choose from, it's easy to find a pump for your needs. The impeller design gives you efficiency and solids handling capability. This helps to ensure smooth operation and delivers savings in terms of maintenance costs and energy consumption. All pumps in the series feature a motor designed for reliable operation in submersible applications. The motors have F-class insulation or better, which allows for continuous running without overheating, ensuring optimal cooling and a long life. Additionally, the pumps can handle 15 starts per hour without any problem. Typically these pumps are installed in permanent installations. However, some models have the option of a free-standing installation so that the pump can be easily moved from one site to another. See methods of installation (page 5) for further reference.

### Application areas.

- Domestic sewage pumping stations
- Wastewater pumping stations
- Stormwater pumping stations
- Drainage water
- Groundwater

### Tough to beat.

#### Robust

All components are made from robust materials for easy maintenance and long life.

#### Powerful

The motor is specifically designed for reliable operation in submersible applications and it can run continuously without overheating.

#### Durable

Heavy-duty bearings with long life provide peace of mind.

#### Environmentally friendly

The cooling system is designed to use its surroundings to cool the pump; no use of environmentally hazardous fluids such as oils.

#### Safe and straightforward

Cable entry prevents both cable strain and leakage.

#### Smooth

The double mechanical seal provides extra reliability and protects against leakage.

#### Flexibility

Drilled pump housing, ready for any installation method.

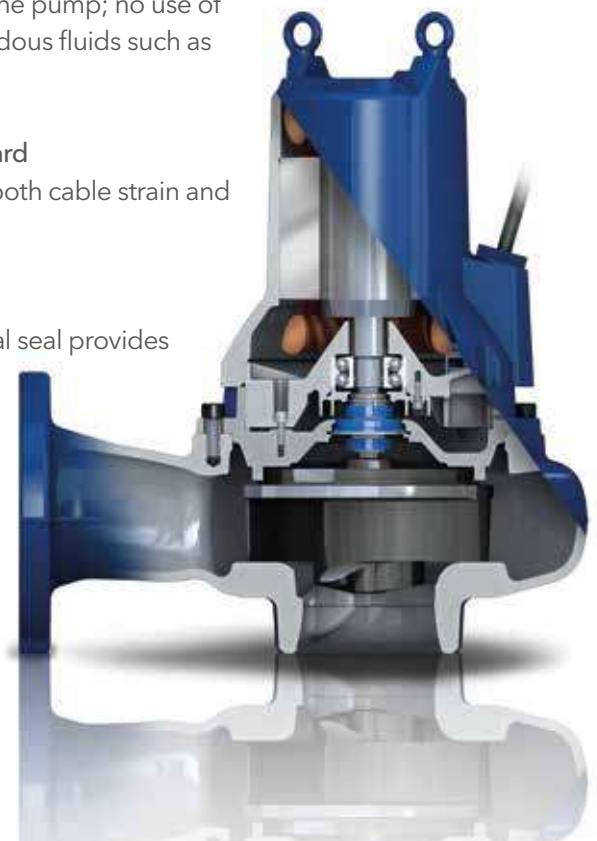

The complete range.  
The right pump for your needs.



**Lowara 1305 Non-clog**  
Maximum flow 14 l/s  
Maximum pressure 17 m  
Motor Rating 0.75 - 1.2 kW  
Outlet 50 mm  
Weight 30 kg



**Lowara 1305 Vortex**  
Maximum flow 10 l/s  
Maximum pressure 11 m  
Motor Rating 0.75 - 1.2 kW  
Outlet 50 mm  
Weight 30 kg



**Lowara 1310 Non-clog**  
Maximum flow 18 l/s  
Maximum pressure 25 m  
Motor Rating 1.4 - 2.4 kW  
Outlet 50 - 80 mm  
Weight 46 kg



**Lowara 1310 Vortex**  
Maximum flow 16 l/s  
Maximum pressure 16 m  
Motor Rating 1.2 - 2.4 kW  
Outlet 50 - 80 mm  
Weight 46 kg



**Lowara 1315 Non-clog**  
Maximum flow 54 l/s  
Maximum pressure 30 m  
Motor Rating 1.8 - 4.4 kW  
Outlet 80 - 100 mm  
Weight 95 kg



**Lowara 1315 Vortex**  
Maximum flow 44 l/s  
Maximum pressure 15 m  
Motor Rating 2.2 - 4.4 kW  
Outlet 65 - 100 mm  
Weight 95 kg



**Lowara 1320 Non-clog**  
Maximum flow 74 l/s  
Maximum pressure 41 m  
Motor Rating 3.5 - 7.5 kW  
Outlet 80 - 100 mm  
Weight 130 - 156 kg



**Lowara 1320 Vortex**  
Maximum flow 54 l/s  
Maximum pressure 29 m  
Motor Rating 3.5 - 7.5 kW  
Outlet 80 - 100 mm  
Weight 140 - 156 kg



**Lowara 1325 Non-clog**  
Maximum flow 115 l/s  
Maximum pressure 63 m  
Motor Rating 9 - 18 kW  
Outlet 80 - 150 mm  
Weight 170 - 190 kg

*\* All Pumps supplied with 10 mtrs cable, 20 mtrs can be supplied if required*

# Installation methods and accessory kits.

The Lowara 1300 series is designed to fit your needs. You start with a bare pump and order the right kit depending on your desired installation method.

## Wet-well kit

The pump is installed with twin guide bars on a discharge connection.

Kit contents:

- Discharge connection
- Anchor bolts
- Guide claw with bolts
- Upper guide bar bracket with bolts

## Replacement kit

Simple kit to replace an old pump or upgrade to a larger model.

Kit contents:

- Guide claw with bolts

## Free-standing kit Ideal for portability

Kit contents:

- Hose connection with bolts
- Stand with bolts

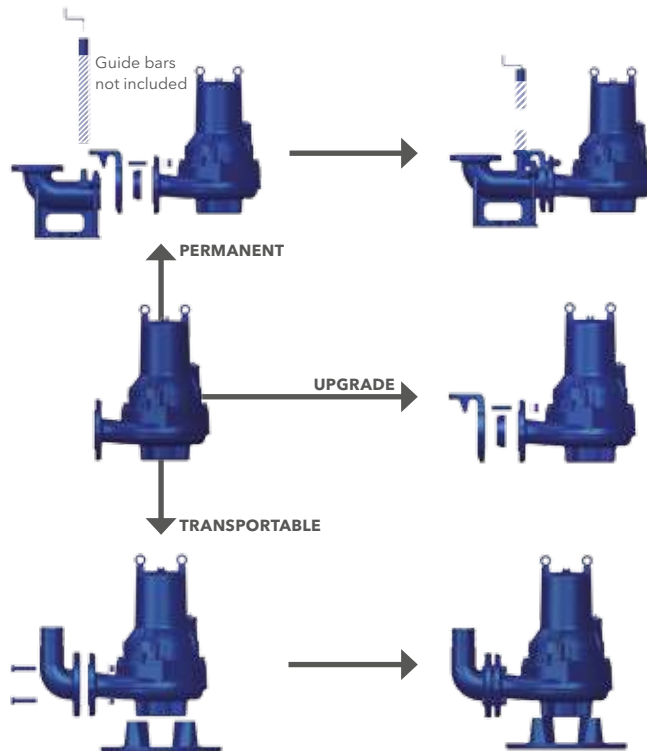

## Selecting & ordering.

### Configure your product order and generate order number

We've made it easy for you to select and configure your pump with appropriate accessories; it can be done in just three simple steps and you build your order number as you go.

**1.** Select the pump model ideal for your needs from the product pages that follow.

**2.** For every model and choice of outlet dimension there is a partially filled order number. Configure your pump from the relevant selection tables and you will automatically get the information to build and complete your order number as you go!

**3.** Select your accessory kit from the relevant accessory selection tables, i.e. installation kit. Please make sure that your configuration corresponds to the right order number and accessory kits and if so you are ready to order.

Model      Model variant      Outlet dimension (nominal, mm)      Pole      Frequency (5=50, 6=60) Phase

1315S-80X.253. ....-....-/-

Selected model      A      B      C      D

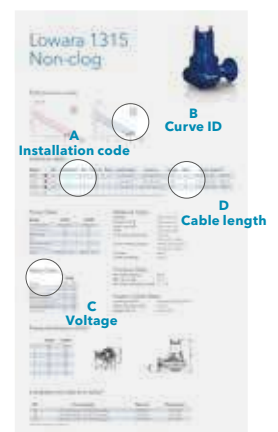

# Lowara® 1305 Non-clog



Performance curves.

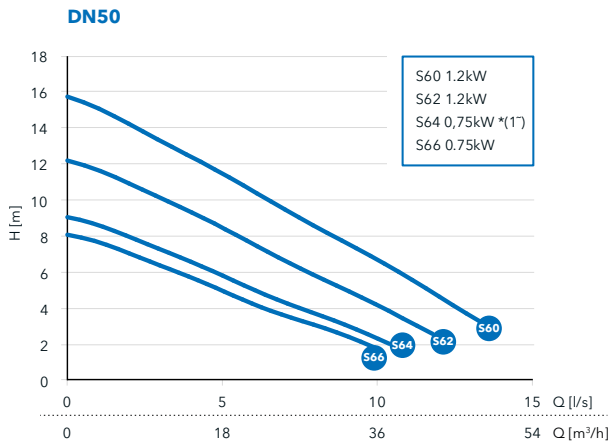

Selection table.

Model	DN	Installation*	Pole	Freq (Hz)	Phase	Rated Power	Curve no	Voltage	Cable	Order number**
1305S	● 50	W, T	2	50	1,3	[see chart]	S60, S62, S64, S66	230, 400	10 mtrs	1305S-50-.25-.....-.../10

\* W=Wet well only. T=Free-standing threaded outlet only.

\*\* For information on configuring the right order number, see page 5. Pumps come standard with thermal switches.

## Pump Data.

Model	1305S
Impeller Type	Non-clog
Outlet size (mm)	50
Weight (kg)	30
Pole	2
Insulation Class	F
Starts per hour	15
Cable	4G1.5 + 2x1.5

## Material Data.

Impeller	grey cast iron
Pump housing	grey cast iron
Stator housing	grey cast iron
Shaft	stainless steel
Inner mechanical seal	carbon/aluminum oxide
Outer mechanical seal	cemented carbide/ aluminum oxide
O-rings	nitrile
Cable sheathing	nitrile

## Motor Data.

	1305S		
Voltage	400	400	230
Phase	3	3	1
Rated Power (kW)	1.2	0.75	0.75
Rated current (A)	2.7	2.1	4.1
Full Load Power Factor	0.79	0.63	1.0
Starting current (A)	17	17	19
Connection	Y	Y	-

## Process Data.

Max submergence	20 m
Max fluid temp	40 °C
pH range of pumped liquid	5.5 - 14

## Power Cable Data.

Cable type (mm <sup>2</sup> )	4G1.5 + 2x1.5
Outer Diameter (mm)	16
Weight (kg/m)	0.32

## Pump dimensions (mm)

Free-standing 1305S		Wet well 1305S	
A	418	A	397
B	298	B	272
C	116	C	116
D	182	D	156
E	97	E	97
F	119	F	120
G	121	G	44

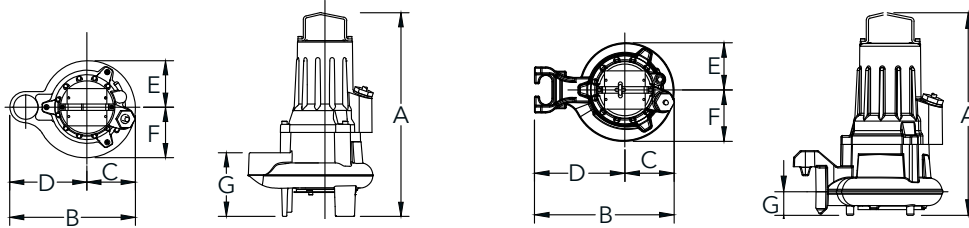

## Installation kit selection table\*

DN	Free-standing	Wet well	Replacement
50	included	1305-50W	included

\* For more information, see page 5

# Lowara® 1305 Vortex



## Performance curves.

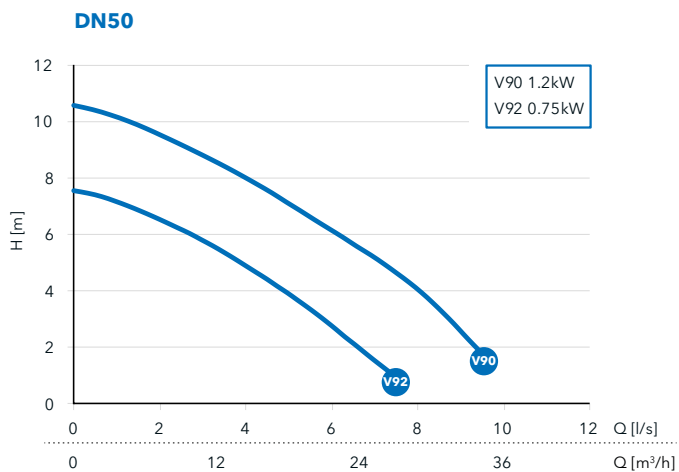

## Selection table.

Model	DN	Installation*	Pole	Freq (Hz)	Phase	Rated Power	Curve no	Voltage	Cable	Order number**
1305H	50	W, T	2	50	1,3	[see chart]	V90, V92	230, 400	10 mtrs	1305H-50-.25-....-./10

\* W=Wet well only. T=Free-standing threaded outlet only.

\*\* For information on configuring the right order number, see page 5. Pumps come standard with thermal switches.

## Pump Data.

Model	1305H
Impeller Type	Vortex
Outlet size (mm)	50
Weight (kg)	30
Pole	2
Insulation Class	F
Starts per hour	15
Cable	4G1.5 + 2x1.5

## Material Data.

Impeller	grey cast iron
Pump housing	grey cast iron
Stator housing	grey cast iron
Shaft	stainless steel
Inner mechanical seal	carbon/aluminum oxide
Outer mechanical seal	cemented carbide/aluminum oxide
O-rings	nitrile
Cable sheathing	nitrile

## Motor Data.

	1305H		
Voltage	400	400	230
Phase	3	3	1
Rated Power (kW)	1.2	0.75	0.75
Rated current (A)	2.7	2.1	4.1
Full Load Power Factor	0.79	0.63	1.0
Starting current (A)	17	17	19
Connection	Y	Y	-

## Process Data.

Max submergence	20 m
Max fluid temp	40 °C
pH range of pumped liquid	5.5 - 14

## Power Cable Data.

Cable type (mm <sup>2</sup> )	4G1.5 + 2x1.5
Outer Diameter (mm)	16
Weight (kg/m)	0.32

## Pump dimensions (mm)

	Free-standing 1305H
A	465
B	299
C	116
D	183
E	103
F	114
G	140

	Wet well 1305H
A	423
B	272
C	116
D	156
E	104
F	114
G	50

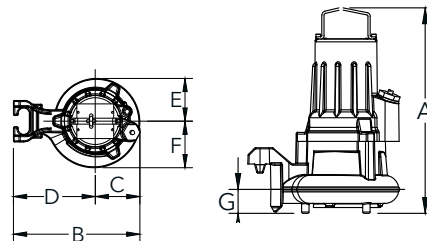
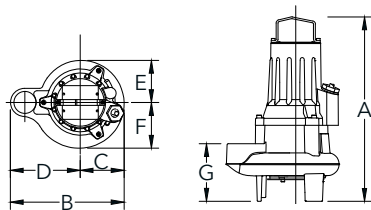

## Installation kit selection table\*

DN	Free-standing	Wet well	Replacement
50	included	1305-50W	included

\* For more information, see page 5



# Lowara® 1310 Non-clog



Performance curves.

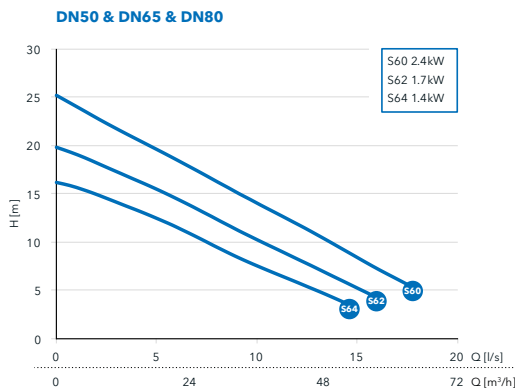

Selection table.

Model	DN	Installation*	Pole	Freq (Hz)	Phase	Rated Power	Curve no	Voltage	Cable	Order number**
1310S	50	W, T	2	50	1,3	[see chart]	S60, S62, S64	230, 400	10 mtrs	1310S-50-.25-.....-/10
1310S	65	X	2	50	1,3	[see chart]	S60, S62, S64	230, 400	10 mtrs	1310S-65X.25-.....-/10
1310S	80	X	2	50	1,3	[see chart]	S60, S62, S64	230, 400	10 mtrs	1310S-80X.25-.....-/10

\* W=Wet well only. T=Free-standing threaded outlet only.

\*\* For information on configuring the right order number, see page 5. Pumps come standard with thermal switches.

## Pump Data.

Model	1310S
Impeller Type	Non-clog
Outlet size (mm)	50   65   80
Weight (kg)	46
Pole	2
Insulation Class	F
Starts per hour	15
Cable	4G1.5 + 2x1.5

## Material Data.

Impeller	grey cast iron
Pump housing	grey cast iron
Stator housing	grey cast iron
Shaft	stainless steel
Inner mechanical seal	carbon/aluminum oxide
Outer mechanical seal	cemented carbide/ aluminum oxide
O-rings	nitrile
Cable sheathing	nitrile

## Motor Data.

	1310S					
	400	400	400	230	230	230
Voltage	400	400	400	230	230	230
Phase	3	3	3	1	1	1
Rated Power (kW)	2.4	1.7	1.4	2.4	1.7	1.4
Rated current (A)	5	3.7	3.3	14.3	9.9	8.3
Full Load Power Factor	0.86	0.79	0.73	0.96	0.95	0.94
Starting current (A)	27	27	27	48	48	48
Connection	Y	Y	-	-	-	-

## Process Data.

Max submergence	20 m
Max fluid temp	40 °C
pH range of pumped liquid	5.5 - 14

## Power Cable Data.

Cable type (mm²)	4G1.5 + 2x1.5
Outer Diameter (mm)	16
Weight (kg/m)	0.32

## Pump dimensions (mm)

Free-standing 1310S	
A	433
B	304
C	112
D	192
E	103
F	123
G	121

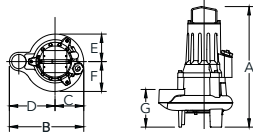

Wet well 1310S	
A	422
B	287
C	112
D	175
E	103
F	123
G	45

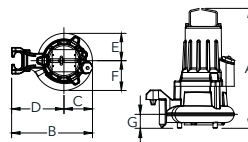

X-installation 1310S	
A	457
B	318
C	118
D	200
E	103
F	123
G	100

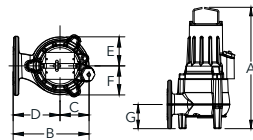

## Installation kit selection table\*

DN	Free-standing	Wet well	Replacement
50	included	1305-50W	included
65	1310-65H (hose), 1310-65T (threaded)	1310-65W	1310-65R
80	1310-80H (hose), 1310-80T (threaded)	1310-80W	1310-80R

\* For more information, see page 5

# Lowara® 1310 Vortex



## Performance curves.

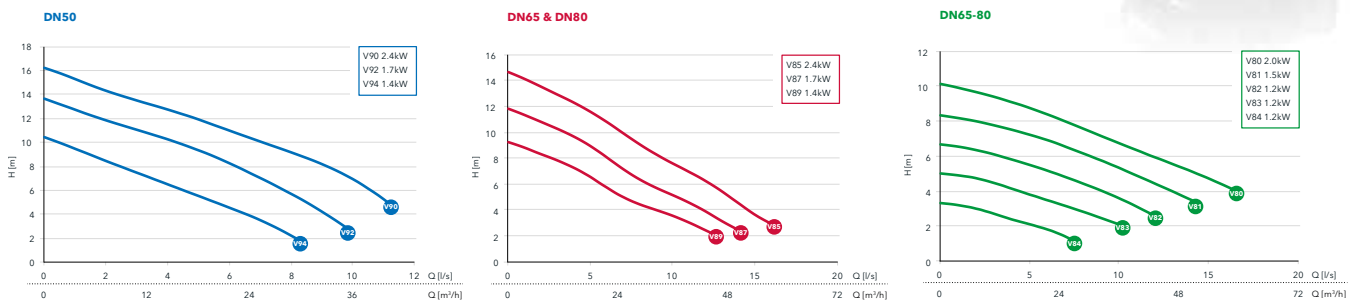

## Selection table.

Model	DN	Installation*	Pole	Freq (Hz)	Phase	Rated Power	Curve no	Voltage	Cable	Order number**
1310H	50	W, T	2	50	1,3	[see chart]	V90, V92, V94	230, 400	10 mtrs	1310H-50-.25-...../10
1310M	65	X	2	50	1,3	[see chart]	V85, V87, V89	230, 400	10 mtrs	1310M-65X.25-...../10
1310M	80	X	2	50	1,3	[see chart]	V85, V87, V89	230, 400	10 mtrs	1310M-80X.25-...../10
1310L	65-80	X	2	50	1,3	[see chart]	V80, V81, V82, V83, V84	230, 400	10 mtrs	1310L-65-80X.45-...../10

\* W=Wet well only. T=Free-standing threaded outlet only.

\*\* For information on configuring the right order number, see page 5. Pumps come standard with thermal switches.

## Pump Data.

Model	1310H/M	1310L
Impeller Type	Vortex	Vortex
Outlet size (mm)	50   65   80	65-80
Weight (kg)	46	46
Pole	2	4
Insulation Class	F	F
Starts per hour	15	15
Cable	4G1.5 + 2x1.5	4G1.5 + 2x1.5

## Material Data.

Impeller	grey cast iron
Pump housing	grey cast iron
Stator housing	grey cast iron
Shaft	stainless steel
Inner mechanical seal	carbon/aluminum oxide
Outer mechanical seal	cemented carbide/ aluminum oxide
O-rings	nitrile
Cable sheathing	nitrile

## Motor Data.

	1310H/M						1310L				
	400	400	400	230	230	230	400	400	400	230	230
Voltage	400	400	400	230	230	230	400	400	400	230	230
Phase	3	3	3	1	1	1	3	3	3	1	1
Rated Power (kW)	2.4	1.7	1.4	2.4	1.7	1.7	2	1.5	1.2	1.3	1.0
Rated current (A)	5	3.7	3.3	14.3	9.9	8.3	4.8	3.8	3.4	8.3	6.5
Full Load Power Factor	0.86	0.79	0.73	0.96	0.95	0.94	0.85	0.77	0.7	1.0	1.0
Starting current (A)	27	27	27	48	48	48	19	19	19	28	28
Connection	Y	Y	Y	-	-	-	Y	Y	Y	-	-

## Process Data.

Max submergence	20 m
Max fluid temp	40 °C
pH range of pumped liquid	5.5 - 14

## Power Cable Data.

Cable type (mm <sup>2</sup> )	4G1.5 + 2x1.5
Outer Diameter (mm)	16
Weight (kg/m)	0.32

## Pump dimensions (mm)

	Free-standing 1310H			Wet well 1310H			X-installation	
	1310M	1310L		1310M	1310L	1310M	1310L	
A	503			455		535	464	
B	310			285		259	346	
C	120			119		99	146	
D	190			166		160	200	
E	115			114		106	146	
F	125			124		106	146	
G	165			53		100	85	

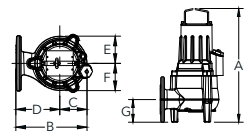
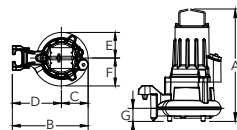
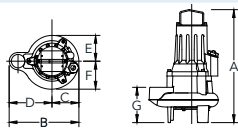

## Installation kit selection table\*

DN	Free-standing	Wet well	Replacement
50	included	1310-50W	Included
65	1310-65H (hose), 1310-65T (threaded)	1310-65W	1310-65R
80	1310-80H (hose), 1310-80T (threaded)	1310-80W	1310-80R

\* For more information, see page 5

# Lowara® 1315 Non-clog



Performance curves.

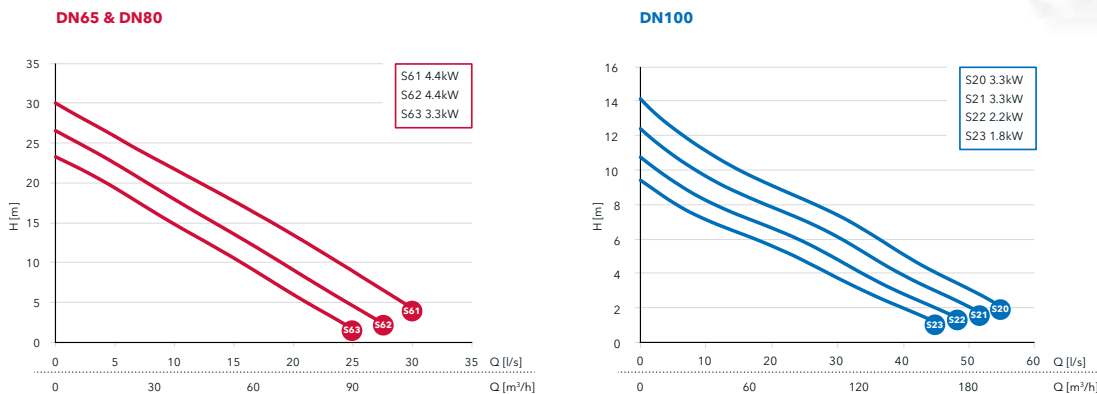

Selection table.

Model	DN	Installation*	Pole	Freq (Hz)	Phase	Rated Power	Curve no	Voltage	Cable	Order number**
1315S	65	X	2	50	3	[see chart]	S61, S62, S63	400	10 mtrs	1315S-65X.253....400/10
1315S	80	X	2	50	3	[see chart]	S61, S62, S63	400	10 mtrs	1315S-80X.253....400/10
1315M	100	X	4	50	3	[see chart]	S20, S21, S22, S23	400	10 mtrs	1315M-100X.453....400/10

\* X=Bare pump.

\*\* For information on configuring the right order number, see page 5. Pumps come standard with thermal switches.

## Pump Data.

Model	1315S	1315M
Impeller Type	Non-clog	Non-clog
Outlet size (mm)	80	100
Weight (kg)	95	95
Pole	2	4
Insulation Class	F	F
Starts per hour	15	15
Cable	7G2.5 + 2x1.5	4G1.5 + 2x1.5

## Material Data.

Impeller	grey cast iron
Pump housing	grey cast iron
Stator housing	grey cast iron
Shaft	stainless steel
Inner mechanical seal	carbon/ aluminum oxide
Outer mechanical seal	cemented carbide/ aluminum oxide
O-rings	nitrile
Cable sheathing	nitrile

## Motor Data.

Voltage	1315S		1315M		
	400	400	400	400	400
Phase	3	3	3	3	3
Rated Power (kW)	4.4	3.3	3.3	2.2	1.8
Rated current (A)	8.5	6.5	7.3	5.3	4.8
Full Load Power Factor	0.9	0.86	0.83	0.73	0.67
Starting current (A)	49	49	33	33	33
Connection	YD	YD	Y	Y	Y

## Process Data.

Max submergence	20 m
Max fluid temp	40 °C
pH range of pumped liquid	5.5 - 14

## Power Cable Data.

Cable type (mm <sup>2</sup> )	7G2.5+2x1.5 4G1.5+2x1.5
Outer Diameter (mm)	26   16
Weight (kg/m)	0.60   0.32

## Pump dimensions (mm)

	1315S	1315M
A	508	524
B	377	464
C	147	179
D	230	285
E	146	161
F	148	194
G	90	109

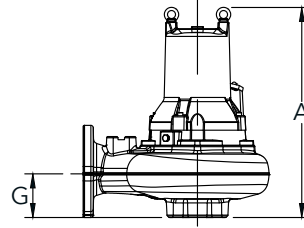
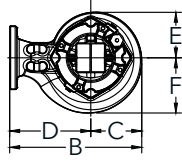

## Installation kit selection table\*

DN	Free-standing	Wet well	Replacement
65	1315-65H (hose), 1315-65T (threaded)	1315-65W	1315-65R
150	1315-80H (hose), 1315-80T (threaded)	1315-80W	1315-80R
250	1315-100H (hose), 1315-100T (threaded)	1315-100W	1315-100R

\* For more information, see page 5

# Lowara® 1315 Vortex



## Performance curves.

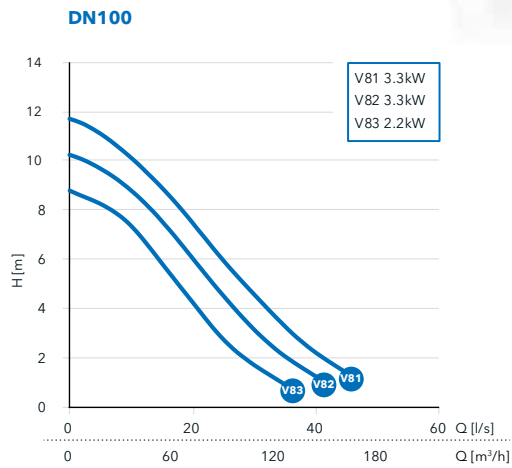
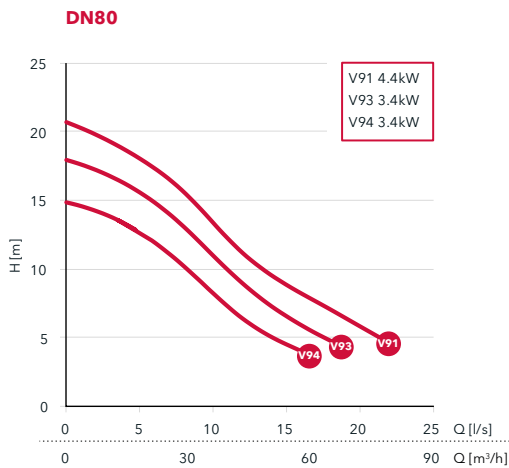

## Selection table.

Model	DN	Installation*	Pole	Freq (Hz)	Phase	Rated Power	Curve no	Voltage	Cable	Order number**
1315S	80	X	2	50	3	[see chart]	V91, V93, V94	400	10 mtrs	1315H-80X.253....400/10
1315M	100	X	4	50	3	[see chart]	V81, V82, V83	400	10 mtrs	1315M-100X.453....400/10

\* X=Bare pump.

\*\* For information on configuring the right order number, see page 5. Pumps come standard with thermal switches.

## Pump Data.

Model	1315H	1315M
Impeller Type	Vortex	Vortex
Outlet size (mm)	65   80	100
Weight (kg)	95	95
Pole	2	4
Insulation Class	F	F
Starts per hour	15	15
Cable	7G2.5 + 2x1.5	4G1.5 + 2x1.5

## Material Data.

Impeller	grey cast iron
Pump housing	grey cast iron
Stator housing	grey cast iron
Shaft	stainless steel
Inner mechanical seal	carbon/ aluminum oxide
Outer mechanical seal	cemented carbide/ aluminum oxide
O-rings	nitrile
Cable sheathing	nitrile

## Motor Data.

	1315H		1315M	
	400	400	400	400
Voltage	400	400	400	400
Phase	3	3	3	3
Rated Power (kW)	4.4	3.3	3.3	2.2
Rated current (A)	8.5	6.5	7.3	5.3
Full Load Power Factor	0.9	0.86	0.83	0.73
Starting current (A)	49	49	33	33
Connection	YD	YD	Y	Y

## Process Data.

Max submergence	20 m
Max fluid temp	40 °C
pH range of pumped liquid	5.5 - 14

## Power Cable Data.

Cable type (mm <sup>2</sup> )	7G2.5+2x1.5 4G1.5+2x1.5
Outer Diameter (mm)	26   16
Weight (kg/m)	0.60   0.32

## Pump dimensions (mm)

	1315H	1315M
A	523	573
B	342	367
C	142	142
D	200	225
E	144	148
F	145	147
G	100	120

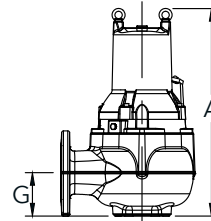
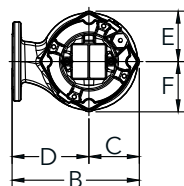

## Installation kit selection table\*

DN	Free-standing	Wet well	Replacement
65	1315-65H (hose), 1315-65T (threaded)	1315-65W	1315-65R
80	1315-80H (hose), 1315-80T (threaded)	1315-80W	1315-80R
100	1315-100H (hose), 1315-100T (threaded)	1315-100W	1315-100R

\* For more information, see page 5

# Lowara® 1320 Non-clog



Performance curves.

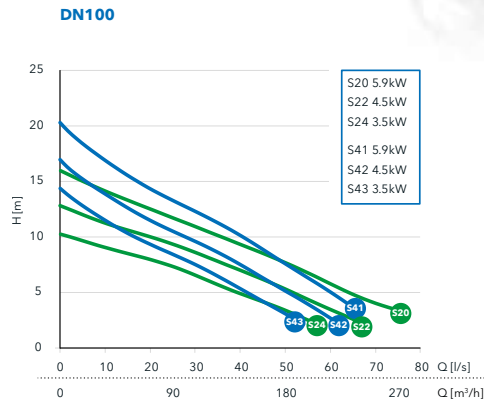
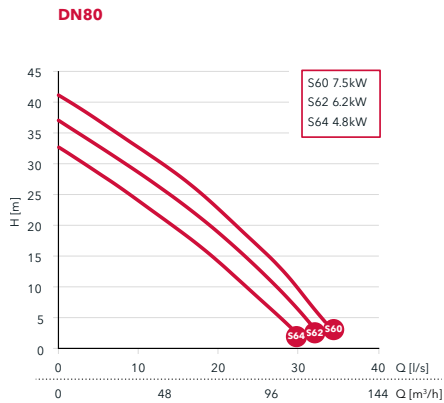

Selection table.

Model	DN	Installation*	Pole	Freq (Hz)	Phase	Rated Power	Curve no	Voltage	Cable	Order number**
1320S	80	X	2	50	3	[see chart]	S60, S62, S64	400	10 mtrs	1320S-80X.253....400/10
1320H	100	X	4	50	3	[see chart]	S41, S42, S43	400	10 mtrs	1320H-100X.453....400/10
1320M	100	X	4	50	3	[see chart]	S20, S22, S24	400	10 mtrs	1320M-100X.453....400/10

\* X=Bare pump.

\*\* For information on configuring the right order number, see page 5. Pumps come standard with thermal switches.

## Pump Data.

Model	1320S	1320H	1320M
Impeller Type	Non-clog	Non-clog	Non-clog
Outlet size (mm)	80	100	100
Weight (kg)	130	140	156
Pole	2	4	4
Insulation Class	F	F	F
Starts per hour	15	15	15
Cable	7G2.5 + 2x1.5	7G2.5 + 2x1.5	7G2.5 + 2x1.5

## Material Data.

Impeller	grey cast iron
Pump housing	grey cast iron
Stator housing	grey cast iron
Shaft	stainless steel
Inner mechanical seal	carbon/ cemented carbide
Outer mechanical seal	cemented carbide/ cemented carbide
O-rings	nitrile
Cable sheathing	nitrile

## Motor Data.

Voltage	1320S			1320H/M		
	400	400	400	400	400	400
Phase	3	3	3	3	3	3
Rated Power (kW)	7.5	6.2	4.8	5.9	4.5	3.5
Rated current (A)	14	11.9	9.7	12.5	9.9	8.4
Full Load Power Factor	0.88	0.85	0.8	0.82	0.77	0.7
Starting current (A)	107	107	107	60	60	60
Connection	D	D	D	YD	YD	YD

## Process Data.

Max submergence	20 m
Max fluid temp	40 °C
pH range of pumped liquid	5.5 - 14

## Power Cable Data.

Cable type (mm <sup>2</sup> )	7G2.5 + 2x1.5
Outer Diameter (mm)	22
Weight (kg/m)	0.60

## Pump dimensions (mm)

	1320S	1320H	1320M
A	570	592	618
B	425	523	523
C	165	213	213
D	260	310	310
E	151	194	180
F	172	232	214
G	90	117	124

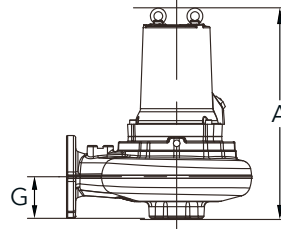
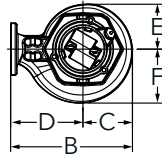

## Installation kit selection table\*

DN	Free-standing	Wet well	Replacement
80	1320-80H (hose), 1320-80T (threaded)	1320-80W	1320-80R
100	1320-100H (hose), 1320-100T (threaded)	1320-100W	1320-100R

\* For more information, see page 5

# Lowara® 1320 Vortex



## Performance curves.

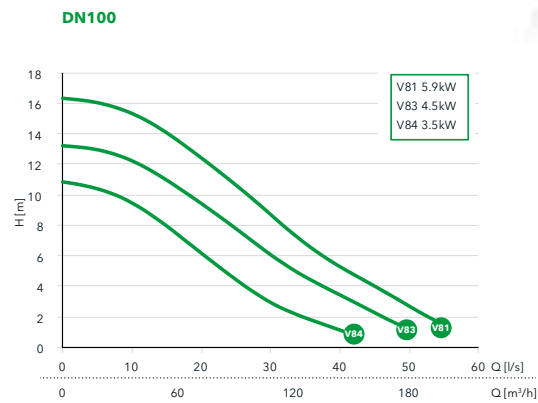
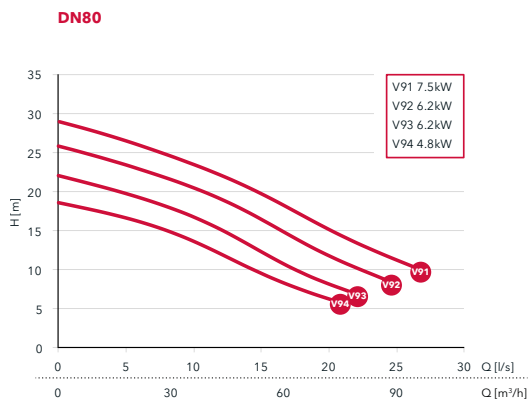



## Selection table.

Model	DN	Installation*	Pole	Freq (Hz)	Phase	Rated Power	Curve no	Voltage	Cable	Order number**
1320H	80	X	2	50	3	[see chart]	V91, V92, V93, V94	400	10 mtrs	1320H-80X.253....400/10
1320M	100	X	4	50	3	[see chart]	V81, V83, V84	400	10 mtrs	1320M-100X.453....400/10

\* X=Bare pump.

\*\* For information on configuring the right order number, see page 5. Pumps come standard with thermal switches.

## Pump Data.

Model	1320H	1320M
Impeller Type	Vortex	Vortex
Outlet size (mm)	80	100
Weight (kg)	140	156
Pole	2	4
Insulation Class	F	F
Starts per hour	15	15
Cable	7G2.5 + 2x1.5	7G2.5 + 2x1.5

## Material Data.

Impeller	grey cast iron
Pump housing	grey cast iron
Stator housing	grey cast iron
Shaft	stainless steel
Inner mechanical seal	carbon/ cemented carbide
Outer mechanical seal	cemented carbide/ cemented carbide
O-rings	nitrile
Cable sheathing	nitrile

## Motor Data.

	1320H			1320M		
	400	400	400	400	400	400
Voltage	400	400	400	400	400	400
Phase	3	3	3	3	3	3
Rated Power (kW)	7.5	6.2	4.8	5.9	4.5	3.5
Rated current (A)	14	11.9	9.7	12.5	9.9	8.4
Full Load Power Factor	0.88	0.85	0.8	0.82	0.77	0.7
Starting current (A)	107	107	107	60	60	60
Connection	YD	YD	YD	YD	YD	YD

## Process Data.

Max submergence	20 m
Max fluid temp	40 °C
pH range of pumped liquid	5.5 - 14

## Power Cable Data.

Cable type (mm <sup>2</sup> )	7G2.5 + 2x1.5
Outer Diameter (mm)	22
Weight (kg/m)	0.60

## Pump dimensions (mm)

	1320H	1320M
A	610	674
B	375	419
C	165	174
D	210	245
E	154	166
F	154	167
G	100	123

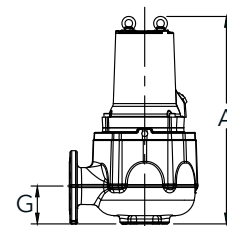
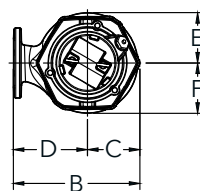

## Installation kit selection table\*

DN	Free-standing	Wet well	Replacement
80	1320-80H (hose), 1320-80T (threaded)	1320-80W	1320-80R
100	1320-100H (hose), 1320-100T (threaded)	1320-100W	1320-100R

\* For more information, see page 5

# Lowara® 1325 Non-clog



Performance curves.

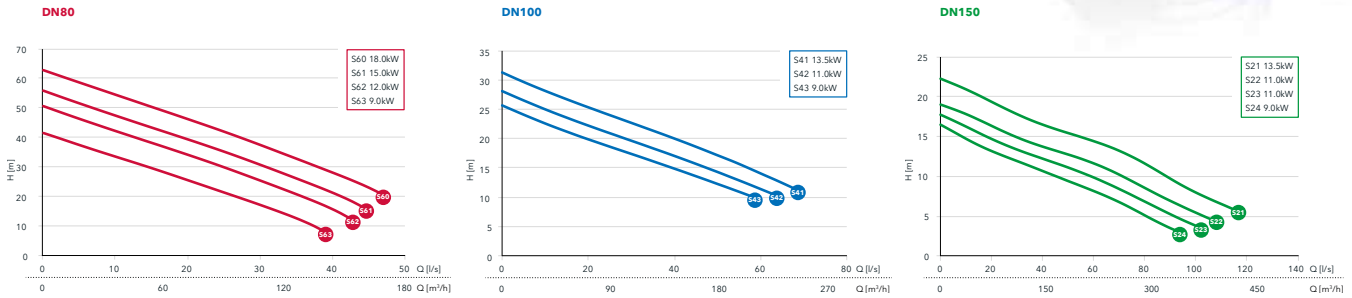

Selection table.

Model	DN	Installation*	Pole	Freq (Hz)	Phase	Rated Power	Curve no	Voltage	Cable	Order number**
1325S	80	X	2	50	3	[see chart]	S60, S61, S62, S63	400	10 mtrs	1325S-80X.253....400/10
1325S	100	X	4	50	3	[see chart]	S41, S42, S43	400	10 mtrs	1325H-100X.453....400/10
1325M	150	X	4	50	3	[see chart]	S21, S22, S23, S24	400	10 mtrs	1325M-150X.453....400/10

\* X=Bare pump.

\*\* For information on configuring the right order number, see page 5. Pumps come standard with thermal switches.

## Pump Data.

Model	1325S	1325H	1325M
Impeller Type	Non-clog	Non-clog	Non-clog
Outlet size (mm)	80	100	150
Weight (kg)	170	180	190
Pole	2	4	4
Insulation Class	F	F	F
Starts per hour	15	15	15
Cable	7G2.5 + 2x1.5	7G2.5 + 2x1.5	7G2.5 + 2x1.5

## Material Data.

Impeller	grey cast iron
Pump housing	grey cast iron
Stator housing	grey cast iron
Shaft	stainless steel
Inner mechanical seal	carbon/ aluminum oxide
Outer mechanical seal	cemented carbide/ cemented carbide
O-rings	nitrile
Cable sheathing	nitrile

## Motor Data.

Voltage	1325S				1325H/M		
	400	400	400	400	400	400	400
Phase	3	3	3	3	3	3	3
Rated Power (kW)	18	15	12	9	13.5	11	9
Rated current (A)	32	27	22	17.9	27	23	19.8
Full Load Power Factor	0.9	0.89	0.86	0.8	0.82	0.79	0.74
Starting current (A)	213	213	213	213	145	145	145
Connection	YD	YD	YD	YD	YD	YD	YD

## Process Data.

Max submergence	20 m
Max fluid temp	40 °C
pH range of pumped liquid	5.5 - 14

## Power Cable Data.

Cable type (mm²)	7G2.5 + 2x1.5
Outer Diameter (mm)	22
Weight (kg/m)	0.60

## Pump dimensions (mm)

	1325S	1325H	1325M
A	650	667	663
B	505	531	550
C	175	201	220
D	330	330	330
E	175	185	187
F	175	220	259
G	82	110	137

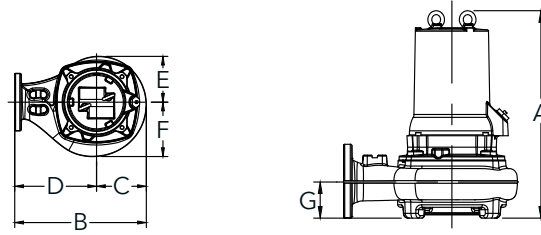

## Installation kit selection table\*

DN	Free-standing	Wet well	Replacement
80	1325-80H (hose), 1325-80T (threaded)	1325-80W	1325-80R
100	1325-100H (hose), 1325-100T (threaded)	1325-100W	1325-100R
150	1325-150H (hose), 1325-150T (threaded)	1325-150W	1325-150R

\* For more information, see page 5

## Other drainage and wastewater products within the Lowara Portfolio.



**DOC SERIES**  
cellar drainage  
pumps

**50 Hz**

Capacity up to 14 m<sup>3</sup>/h  
Head up to 11 m  
Power up to 0,55 kW  
Solids up to 20 mm

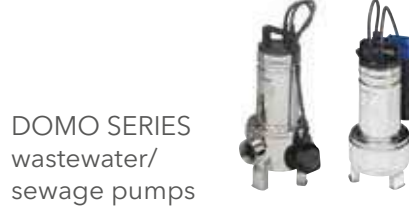

**DOMO SERIES**  
wastewater/  
sewage pumps

**50 Hz**

Capacity up to 40 m<sup>3</sup>/h  
Head up to 14,5 m  
Power up to 1,5 kW  
Solids up to 50 mm



**DOMO GRI SERIES**  
sewage pumps with  
grinder device

**50 Hz**  
Capacity up to 6,6 m<sup>3</sup>/h  
Head up to 25 m  
Power up to 1,1 kW

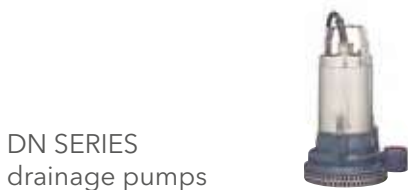

**DN SERIES**  
drainage pumps

**50 Hz**

Capacity up to 16,8 m<sup>3</sup>/h  
Head up to 22 m  
Power up to 0,75 kW  
Solids up to 5 mm

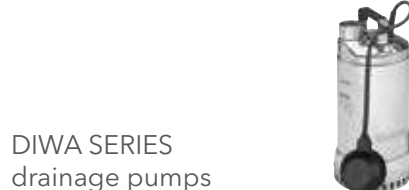

**DIWA SERIES**  
drainage pumps

**50 Hz**

Capacity up to 25 m<sup>3</sup>/h  
Head up to 21 m  
Power up to 1,5 kW  
Solids up to 8 mm

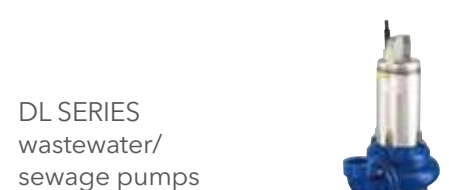

**DL SERIES**  
wastewater/  
sewage pumps

**50 Hz**  
Capacity up to 42 m<sup>3</sup>/h  
Head up to 21,9 m  
Power up to 1,5 kW  
Solids up to 50 mm

**BOX SERIES**  
prefabricated  
lifting stations

Minibox  
Midibox  
Singlebox Plus  
Doublebox Plus  
Maxibox Plus



Volume up to 1900 liters  
Pumps 1 or 2

**SOS FLOODKIT**  
For flooded  
basements  
and garages



Pump type DOC 3  
with 10 metres cable

Can be used in or  
outside the box.

# Xylem |'zīləm|

- 1) The tissue in plants that brings water upward from the roots;
- 2) a leading global water technology company.

We're a global team unified in a common purpose: creating innovative solutions to meet our world's water needs. Developing new technologies that will improve the way water is used, conserved, and reused in the future is central to our work. We move, treat, analyze, and return water to the environment, and we help people use water efficiently, in their homes, buildings, factories and farms. In more than 150 countries, we have strong, long-standing relationships with customers who know us for our powerful combination of leading product brands and applications expertise, backed by a legacy of innovation.

**For more information on how Xylem can help you, go to [xylem.com](http://xylem.com)**



Legal head office  
Xylem Water Solutions Italia Srl

Via Gioacchino Rossini 1/A  
20020 - Lainate (MI) - Italy  
Tel. (+39) 02 90358.1  
Fax (+39) 02 9019990  
[www.xylemwatersolutions.com](http://www.xylemwatersolutions.com)

For information and technical support  
Xylem Service Italia Srl

Via Dottor Vittorio Lombardi 14  
36075 - Montecchio Maggiore (VI) - Italy  
Tel. (+39) 0444 707111  
Fax (+39) 0444 491043  
[www.lowara.com](http://www.lowara.com)

Lowara, HYDROVAR, Xylect are trademarks or registered trademarks of Xylem Inc. or one of its subsidiaries.  
All other trademarks or registered trademarks are property of their respective owners.

Xylem Water Solutions Italia Srl reserves the right to make modification without prior notice.  
Lowara, Xylem are trademarks of Xylem Inc. or one of its subsidiaries. © 2015 Xylem, Inc.

cod. 191004521 - P07/15