

Process Industrial Pumps



A RUTHMAN COMPANY
www.Gusher.com



7071 Series

ANSI Standard Dimension

7071 Series

Process Industrial Pumps

- Capacities to 6000 gpm
- Heads to 750 feet
- Temperatures to 500° F (250° C)
- Pressures to 300 PSIG



Performance Features For General Service

Pump Reliability

- Heavy Duty Construction
- Foot-mounted Casing
- Centerline Intake and Discharge

Ease of Maintenance

- Back Pull-out Design
- Maximum Interchangeability
- Cartridge Seals Available

Simple Installation

- ANSI 16.5 Standard Flanges
- ANSI 73.1 Style Casing

For process industrial services, the 7071 Series is a perfect, reliable, and economical solution.

The 7071 Series is also easy to operate and maintain with the added benefit of substantially reduced maintenance costs.

Services

Food Processing	Liquid Transfer
Chemical	Pulp and Paper
Oil	Pharmaceutical
Textile	Paint Systems
Filtration	and many more...

Custom Design

- Design and Manufacture to your Application Needs

ANSI Standard Dimension

7071 Series Options

Finned Cooler

For high temperature applications.

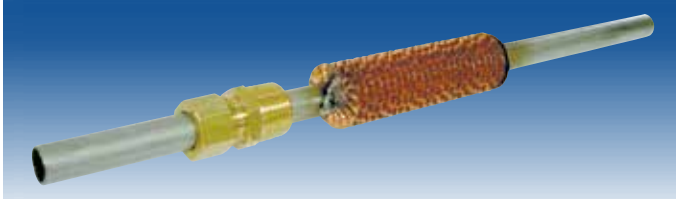

Jacketed Stuffing Box

For high temperature applications. Back pull-out design for ease of maintenance.

Standard Bore Stuffing Box

Accommodates many of today's seal sizes and styles such as cartridges, component and packing.



Base Plates

Gusher has a variety of base plates for your specific requirements.



Cast Iron

Fabricated Steel



Base plates are also supplied with jack bolts to aid in alignment.

Repeller

When seals are not effective, Gusher provides repeller style sealing for abrasive applications.

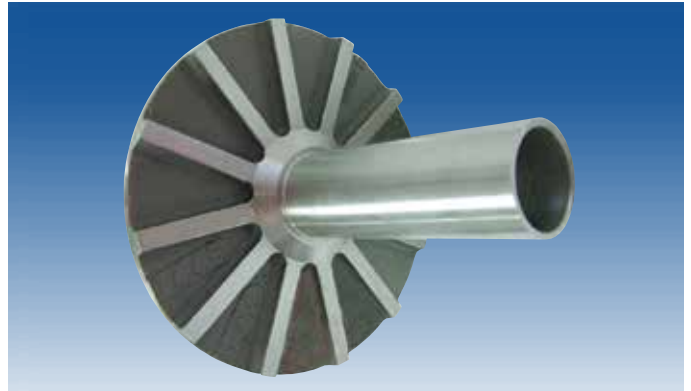

Safety Coupling Guards

Gusher provides guards around rotating parts to meet plant safety requirements.



In-Line Adapter

Convert your centerline close-coupled pump to an in-line.

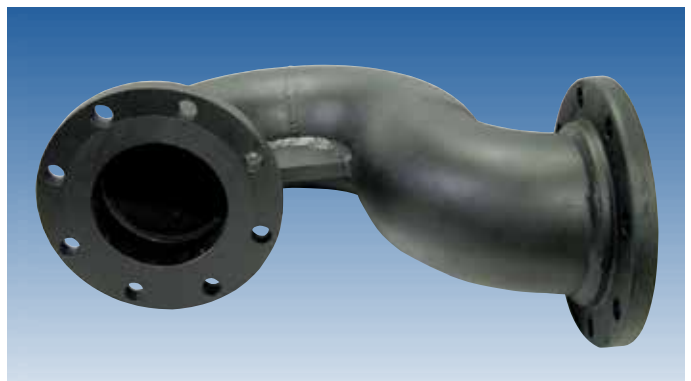

ANSI B-73.1 Design Features

Gusher 7071 Series ANSI Standard Dimension Process Pumps

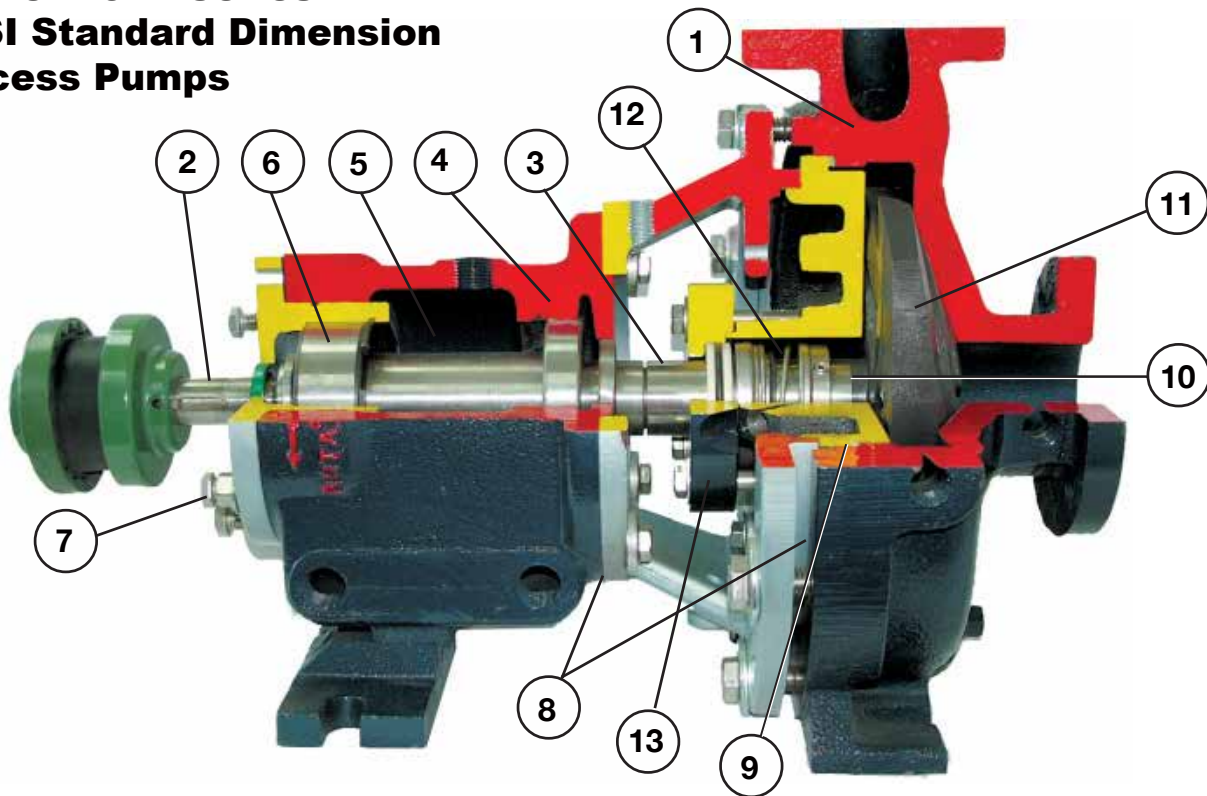











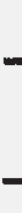









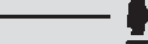

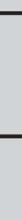

Design Features:

- 1. Heavy Duty Casings**—increases life under corrosive and erosive conditions. All sizes are self venting with CL discharge. Drain plug offered as option.
- 2. Heavy Duty Shaft**—Minimum deflection increases life for less maintenance.
- 3. Renewable Shaft Sleeve**—Hook-type sleeve eases maintenance (easily removed) and is relieved to allow for changes in temperature.
- 4. Power Frame**—Heavy duty Power Frame is sealed against contaminants to ensure long bearing life. Water-cooled for high temperature applications.
- 5. Oil Lubrication**—Oil lubrication is standard. The power frame is vented. Oil may also be cooled for high temperature application.
- 6. Heavy Duty Thrust Bearing**—Double row thrust bearing minimizes shaft end play for more effective stuffing box sealing, longer mechanical seal life and withstands greater axial and radial thrust loads.
- 7. External Impeller Adjustment**—Like new clearance can be maintained through simple external adjustment in just minutes to maintain original high efficiencies.
- 8. Rabbeted Fits**—Accurately machined rabbets ensure positive alignment, longer seal life, easy replacement of spare rotating when maintenance is required.
- 9. Contained Casing Gasket**—Protects against blow out.
- 10. Positive Sealing at Impeller**—Teflon O-ring protects shaft from liquid being pumped.
- 11. Semi Open Impeller**—is designed with back pump-out vane to minimize axial thrust. Designed to handle solids and stringy material.*
- 12. Mechanical Seal**
- 13. Seal Gland**

*The 3x4-16 and the 5x6-16 have enclosed impellers.

Dimensional Interchangeability

Power Frame	Stem	Stem Plate	Impeller	Casing	Size – ANSI Designation	
Series 7071 S  1 3/8" Shaft Dia. Max. BHP – 40 HP					1x1.5-6 AA	
					1.5x3-6 AB	
					2x3-6 A10	
					1x1.5-8 AA	
					1.5x3-8 AB	
Series 7071 M  1 3/4" Shaft Dia. Max. BHP – 122 HP					3x4-7 A70	
					2x3-8 A60	
					3x4-8 A70	
					3x4-8B A70	
					5x6-9*	
					1x2-10 A05	
					1.5x3-10 A50	
					2x3-10 A60	
					3x4-10 A70	
					3x4-10B A40	
					4x6-10 A80	
					4X6-10B A80	
					4x5-11*	
					6x8-11*	
					1.5x3-13 A20	
		2x3-13 A30				
		3x4-13 A40				
		4x6-13 A80				
		6x8-13 A90				
		8x10-13 A100				
Series 7071 L  2 1/2" Shaft Dia. Max. BHP – 350 HP					6x8-15 A110	
					8x10-15 A120	
					8x10-15B A120	
					8x10-15B A120	
					3x4-16*	
					5x6-16*	
					4x6-17*	
					6x8-17*	
8x10-17*						

*No ANSI designation available

7071S Series W/67220 Base

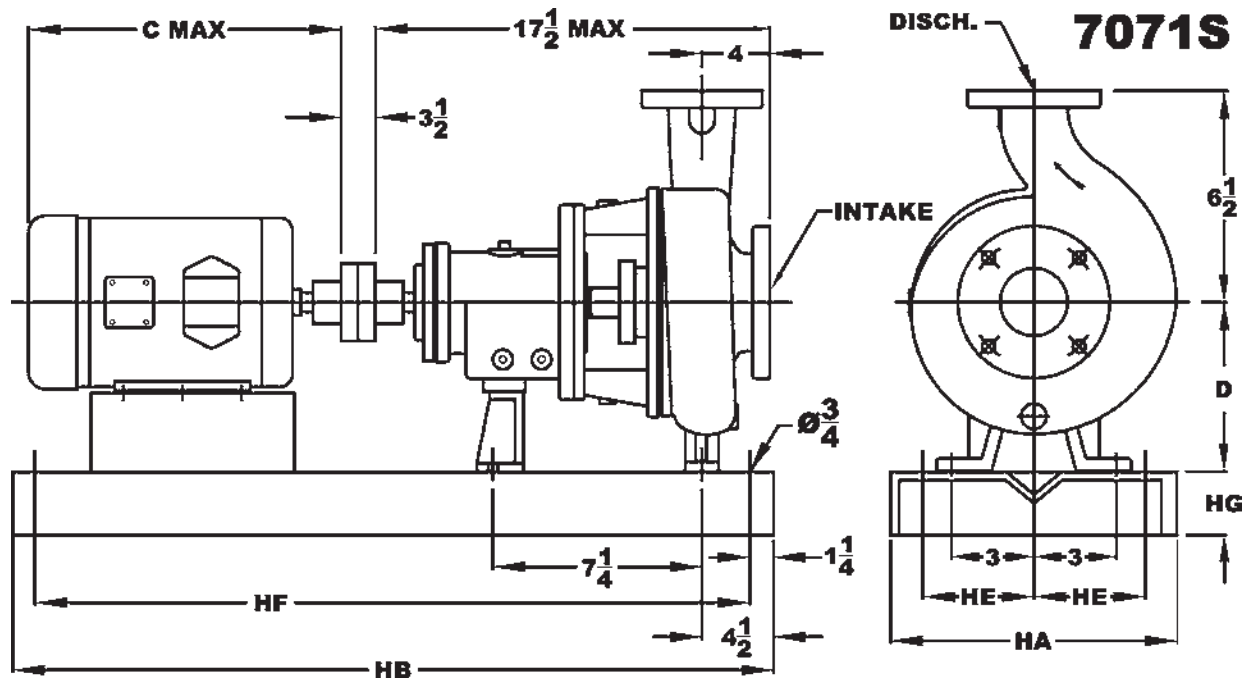

Model	Discharge	Intake	Shaft Dia.	Keyway	Weight
1x1.5-6	1	1.5	7/8	3/16 X 3/32	85
1.5x3-6	1.5	3	7/8	3/16 X 3/32	95
2x3-6	2	3	7/8	3/16 X 3/32	98
1x1.5-8	1	1.5	7/8	3/16 X 3/32	105
1.5x3-8	1.5	3	7/8	3/16 X 3/32	110

NEMA Frm.	Baseplate	C(MAX.)	D	HA	HB	HE	HF	HG
56-145	1S	13 1/2	5 1/4	10	35	4	32 1/2	3
182-215	2S	19 1/2	5 1/4	12	39	4 1/2	36 1/2	3 1/4
254-286	3S	27	6 1/4	15	46	6	43 1/2	4 1/8

7071M Series W/67220 Base

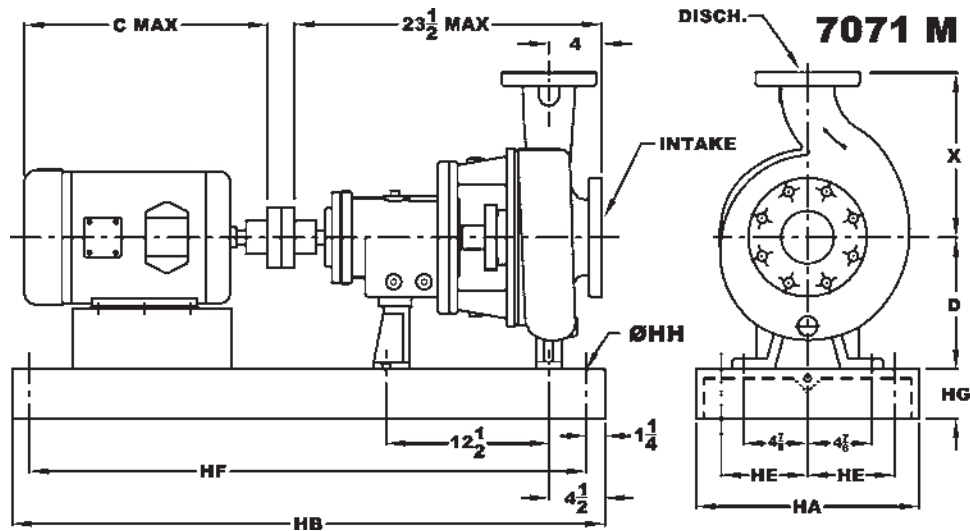

Model	Discharge	Intake	X	D	Shaft Dia.	Keyway	Weight
3x4-7	3	4	11	8 ¹ / ₄	1 ¹ / ₈	1/4 x 1/8	225
2x3-8	2	3	9 ¹ / ₂	8 ¹ / ₄	1 ¹ / ₈	1/4 x 1/8	205
3x4-8	3	4	11	8 ¹ / ₄	1 ¹ / ₈	1/4 x 1/8	225
3x4-8B	3	4	11	8 ¹ / ₄	1 ¹ / ₈	1/4 x 1/8	225
5x6-9*	5	6**	13 ¹ / ₂	10	1 ¹ / ₈	1/4 x 1/8	325
1x2-10	1	2	8 ¹ / ₂	8 ¹ / ₄	1 ¹ / ₈	1/4 x 1/8	205
1.5x3-10	1.5	3	8 ¹ / ₂	8 ¹ / ₄	1 ¹ / ₈	1/4 x 1/8	225
2x3-10	2	3	9 ¹ / ₂	8 ¹ / ₄	1 ¹ / ₈	1/4 x 1/8	235
3x4-10	3	4	11	8 ¹ / ₄	1 ¹ / ₈	1/4 x 1/8	270
3x4-10B	3	4	12 ¹ / ₂	10	1 ¹ / ₈	1/4 x 1/8	280
4x6-10	4	6**	13 ¹ / ₂	10	1 ¹ / ₈	1/4 x 1/8	310
4x6-10B	4	6	13 ¹ / ₂	10	1 ¹ / ₈	1/4 x 1/8	310
4x5-11*	4	5**	13 ¹ / ₂	10	1 ¹ / ₈	1/4 x 1/8	325
6x8-11*	6	8	16	14 ¹ / ₂	1 ¹ / ₈	1/4 x 1/8	475
1.5x3-13	1.5	3	10 ¹ / ₂	10	1 ¹ / ₈	1/4 x 1/8	250
2x3-13	2	3	11 ¹ / ₂	10	1 ¹ / ₈	1/4 x 1/8	280
3x4-13	3	4	12 ¹ / ₂	10	1 ¹ / ₈	1/4 x 1/8	335
4x6-13	4	6**	13 ¹ / ₂	10	1 ¹ / ₈	1/4 x 1/8	410

NEMA Frm.	Baseplate	C	HA	HB	HE	HF	HG	HH
143-215	1M	19 ¹ / ₂	12	45	4 ¹ / ₂	42 ¹ / ₂	3 ³ / ₄	³ / ₄
254-286	2M	27	15	52	6	49 ¹ / ₂	4 ¹ / ₈	1
324-326	3M	30	18	58	7 ¹ / ₂	55 ¹ / ₂	4 ³ / ₄	1
364-365	3M	34	18	58	7 ¹ / ₂	55 ¹ / ₂	5 ³ / ₄ +4 ³ / ₄ **	1
404-405	4M	35 ¹ / ₂	22	60	7 ¹ / ₂	57 ¹ / ₂	6 ³ / ₄ +5**	1
44	4M	46 ¹ / ₂	22	60	7 ¹ / ₂	57 ¹ / ₂	7 ³ / ₄ +6**	1

*No ANSI designation available **Suction flange has 8.75-1 UNC tapped holes *Pump with 8 1/4" D dimension **Pump with 10" D dimension

7071L Series W/67220 Base

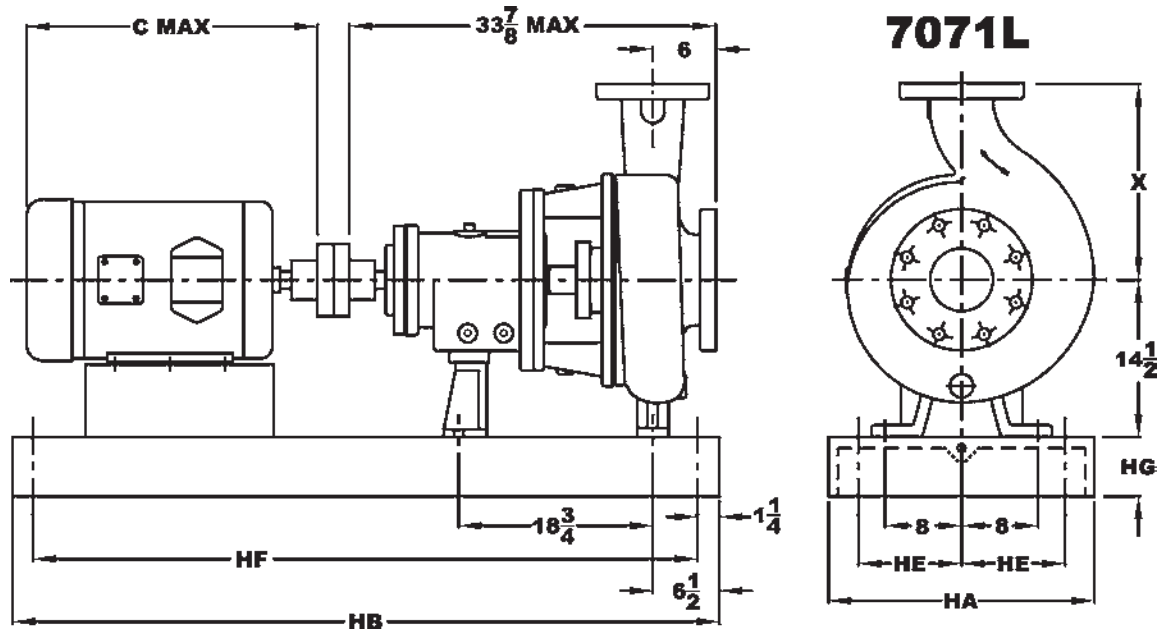

Model	Discharge	Intake	X	Shaft Dia.	Keyway	Weight
6x8-13	6	8	16	2 ³ / ₈	5 ⁵ / ₈ X 5 ⁵ / ₁₆	565
8x10-13	8	10	18	2 ³ / ₈	5 ⁵ / ₈ X 5 ⁵ / ₁₆	575
6x8-15	6	8	18	2 ³ / ₈	5 ⁵ / ₈ X 5 ⁵ / ₁₆	616
8x10-15	8	10	19	2 ³ / ₈	5 ⁵ / ₈ X 5 ⁵ / ₁₆	750
8x10-15B	8	10	19	2 ³ / ₈	5 ⁵ / ₈ X 5 ⁵ / ₁₆	720
4x6-17*	4	6	16	2 ³ / ₈	5 ⁵ / ₈ X 5 ⁵ / ₁₆	650
6x8-17*	6	8	18	2 ³ / ₈	5 ⁵ / ₈ X 5 ⁵ / ₁₆	730
8x10-17*	8	10	19	2 ³ / ₈	5 ⁵ / ₈ X 5 ⁵ / ₁₆	830

NEMA Frm.	Baseplate	C	HA	HB	HE	HF	HG
213-256	1L	24	22	62	9 ¹ / ₂	59 ¹ / ₂	4
284-365	2L	34	22	68	9 ¹ / ₂	65 ¹ / ₂	4 ³ / ₄
404-445	3L	46 ¹ / ₂	22	80	9 ¹ / ₂	77 ¹ / ₂	4 ³ / ₄
447	4L	46 ¹ / ₂	26	90	9 ¹ / ₂	87 ¹ / ₂	4

*No ANSI designation available

7071L Series W/67220 Base

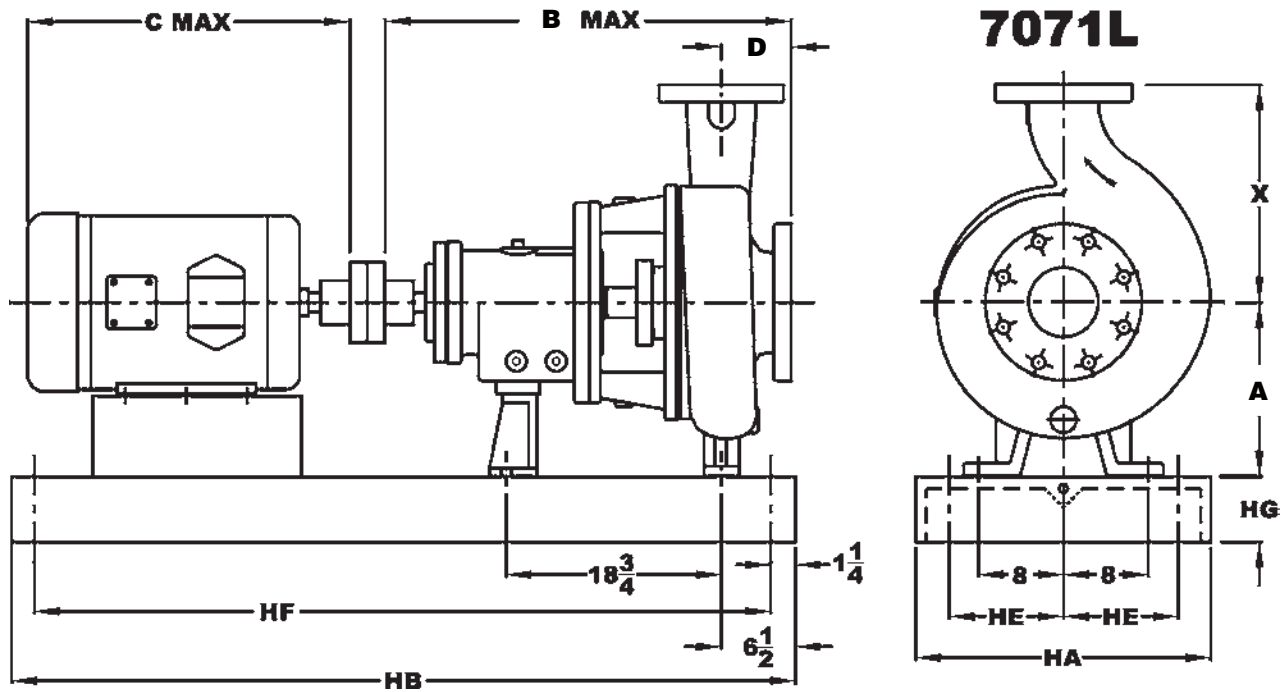

Model	Discharge	Intake	X	A	B	D	Shaft Dia.	Keyway	Weight
3x4-16*	3	4	14	11	33	4 ⁷ / ₈	2 ³ / ₈	5 ⁵ / ₈ X 5 ⁵ / ₁₆	675
5x6-16E*	5	6	15 ³ / ₄	12 ³ / ₈	33	5 ³ / ₄	2 ³ / ₈	5 ⁵ / ₈ X 5 ⁵ / ₁₆	700

NEMA Frm.	Baseplate	C	HA	HB	HE	HF	HG
213-256	1L	24	22	62	9 ¹ / ₂	59 ¹ / ₂	4
284-365	2L	34	22	68	9 ¹ / ₂	65 ¹ / ₂	4 ³ / ₄
404-445	3L	46 ¹ / ₂	22	80	9 ¹ / ₂	77 ¹ / ₂	4 ³ / ₄
447	4L	46 ¹ / ₂	26	90	9 ¹ / ₂	87 ¹ / ₂	4

*No ANSI designation available

Pump Selection Curves

7071 CL 1x1.5-6SE 1765 rpm

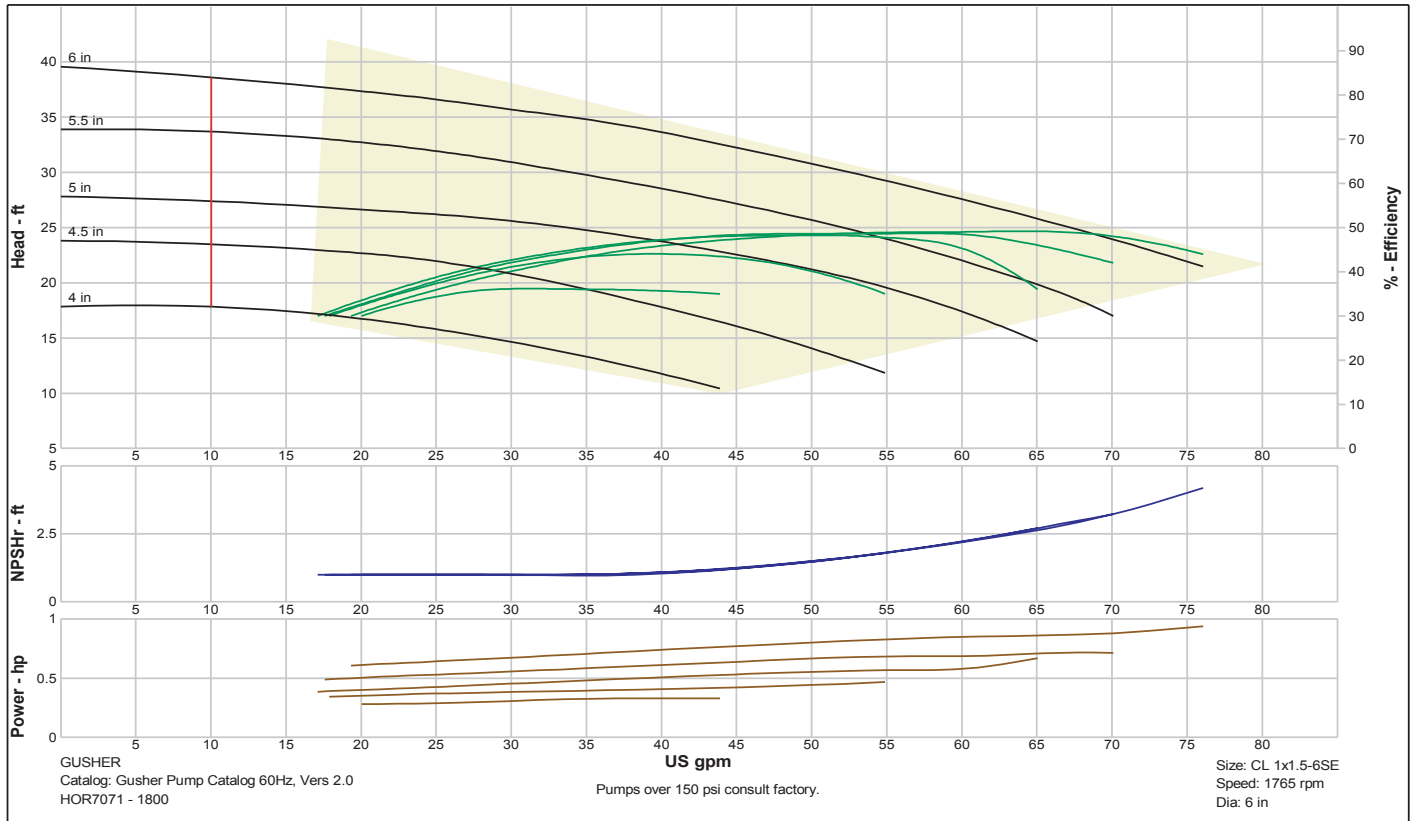

7071 CL 1x1.5-6SE 3480 rpm

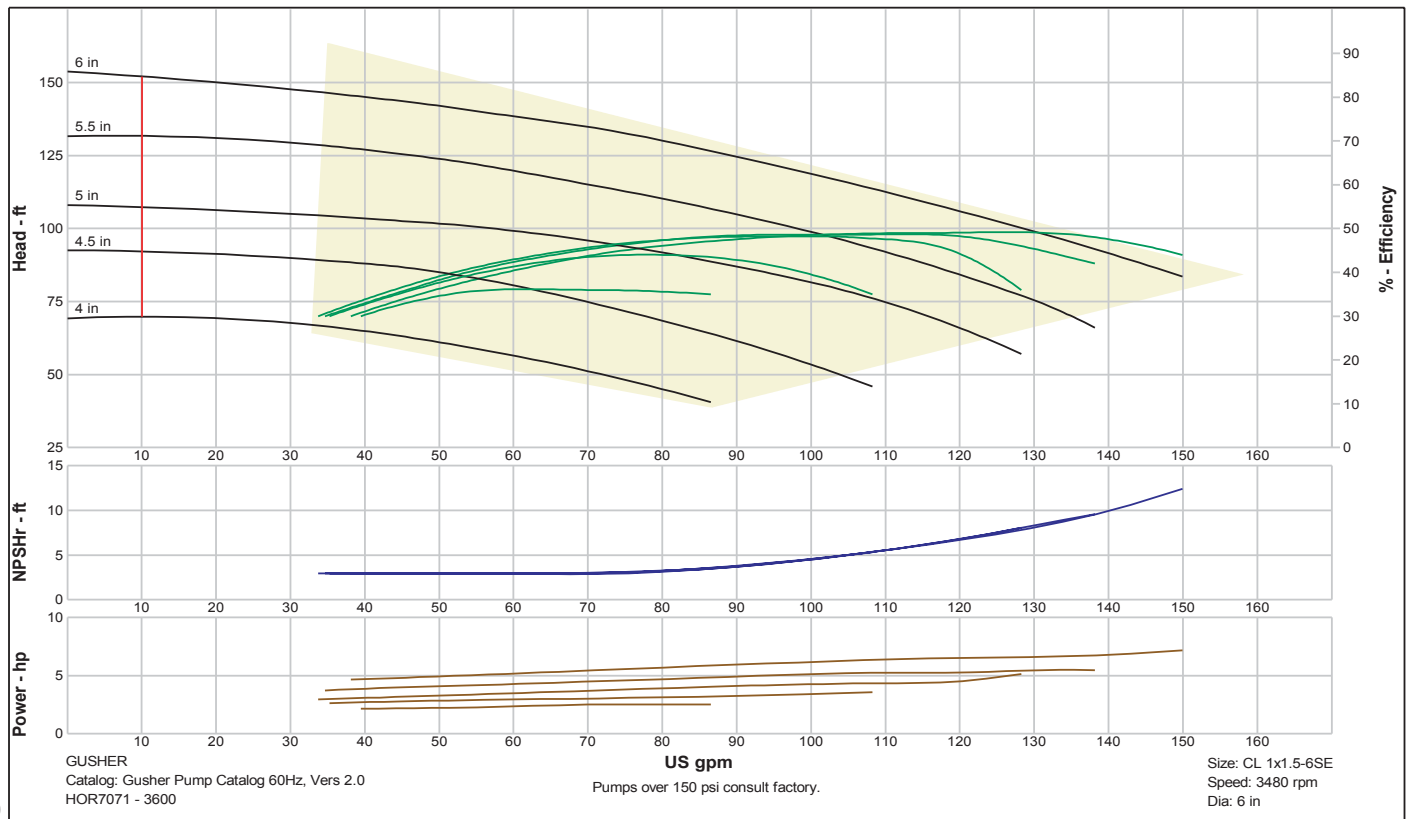

Pump Selection Curves

7071 CL 1.5x3-6SE 1765 rpm

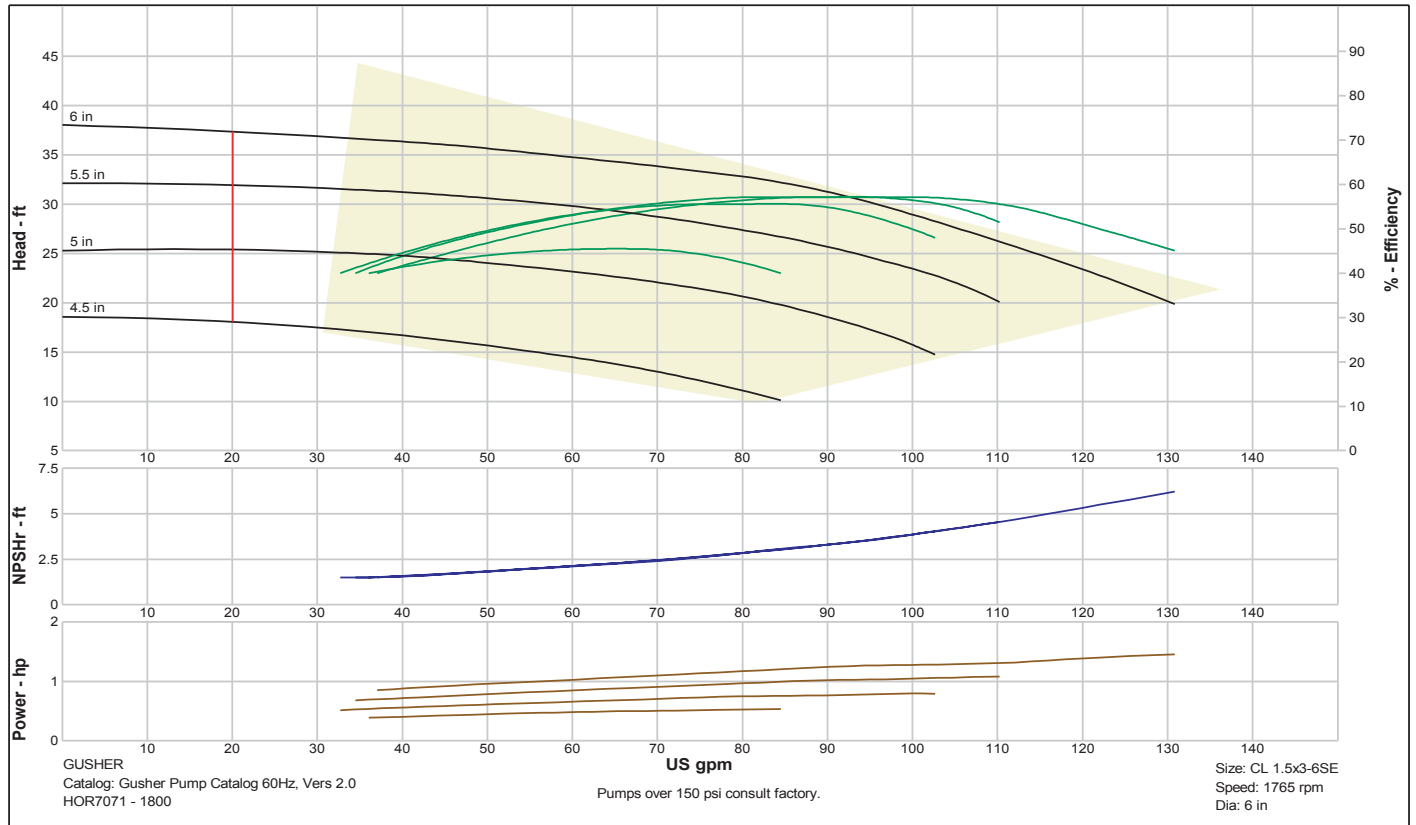

7071 CL 1.5x3-6SE 3480 rpm

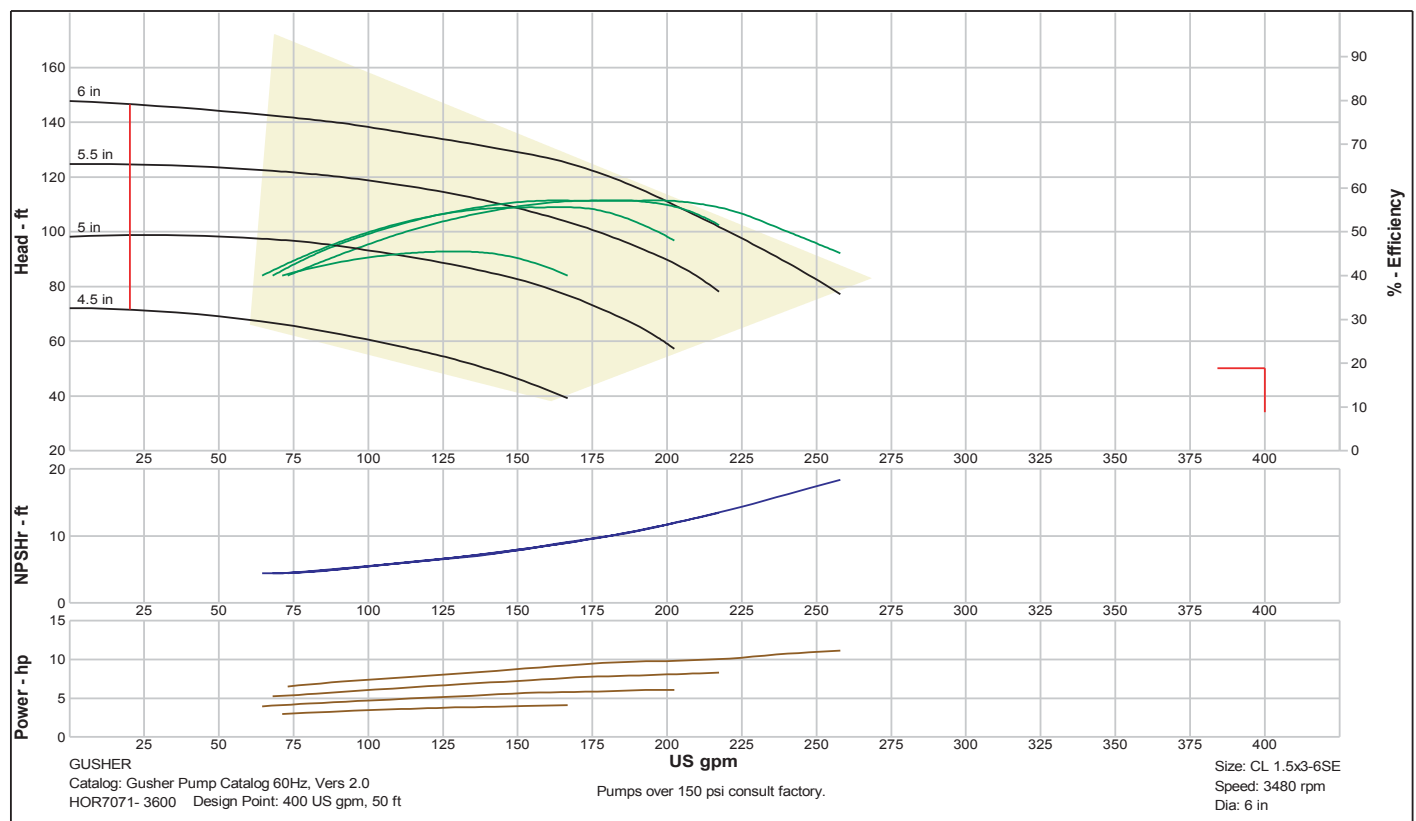

Pump Selection Curves

7071S CL 2x3-6SE 1765 rpm

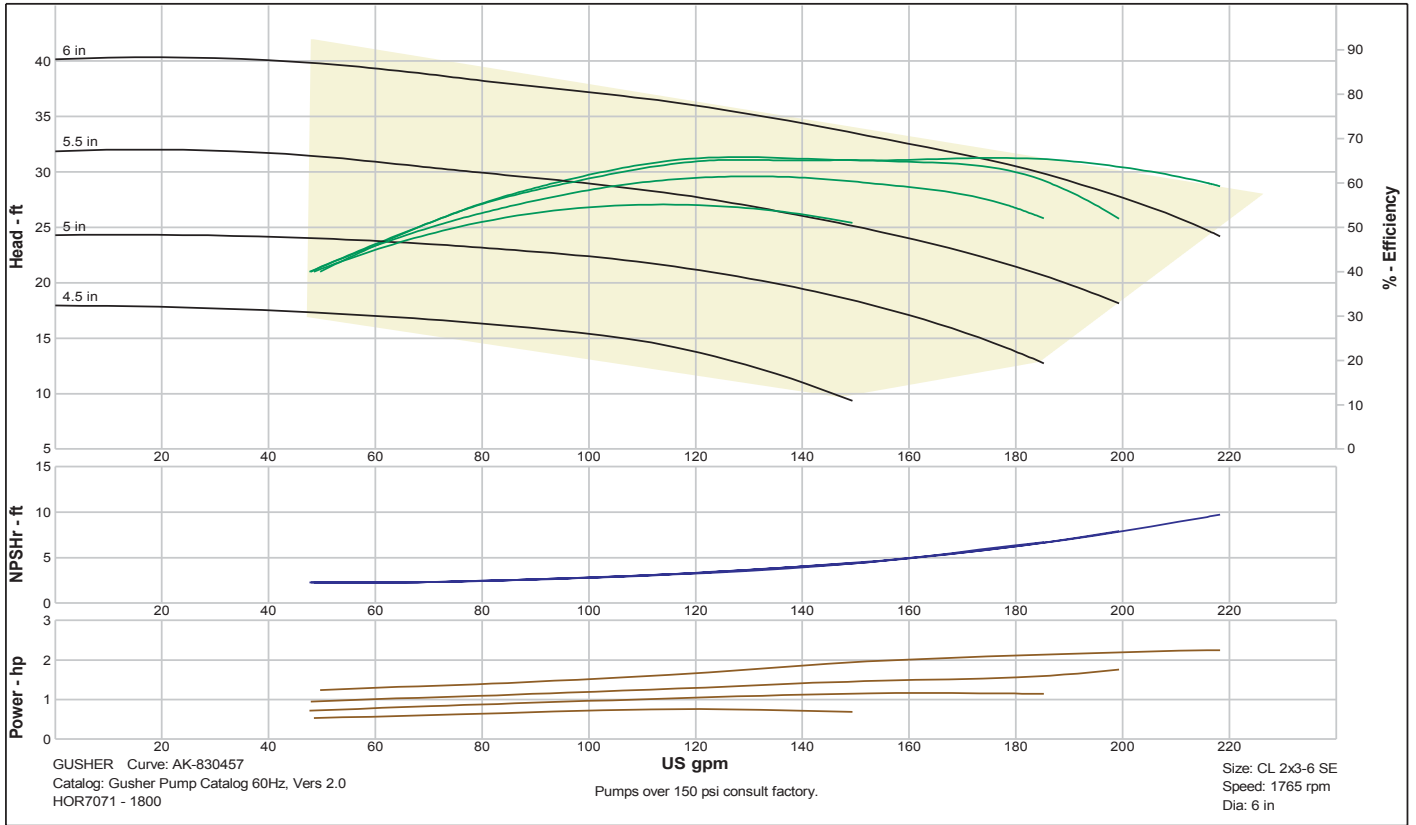

7071S CL 2x3-6SE 3480 rpm

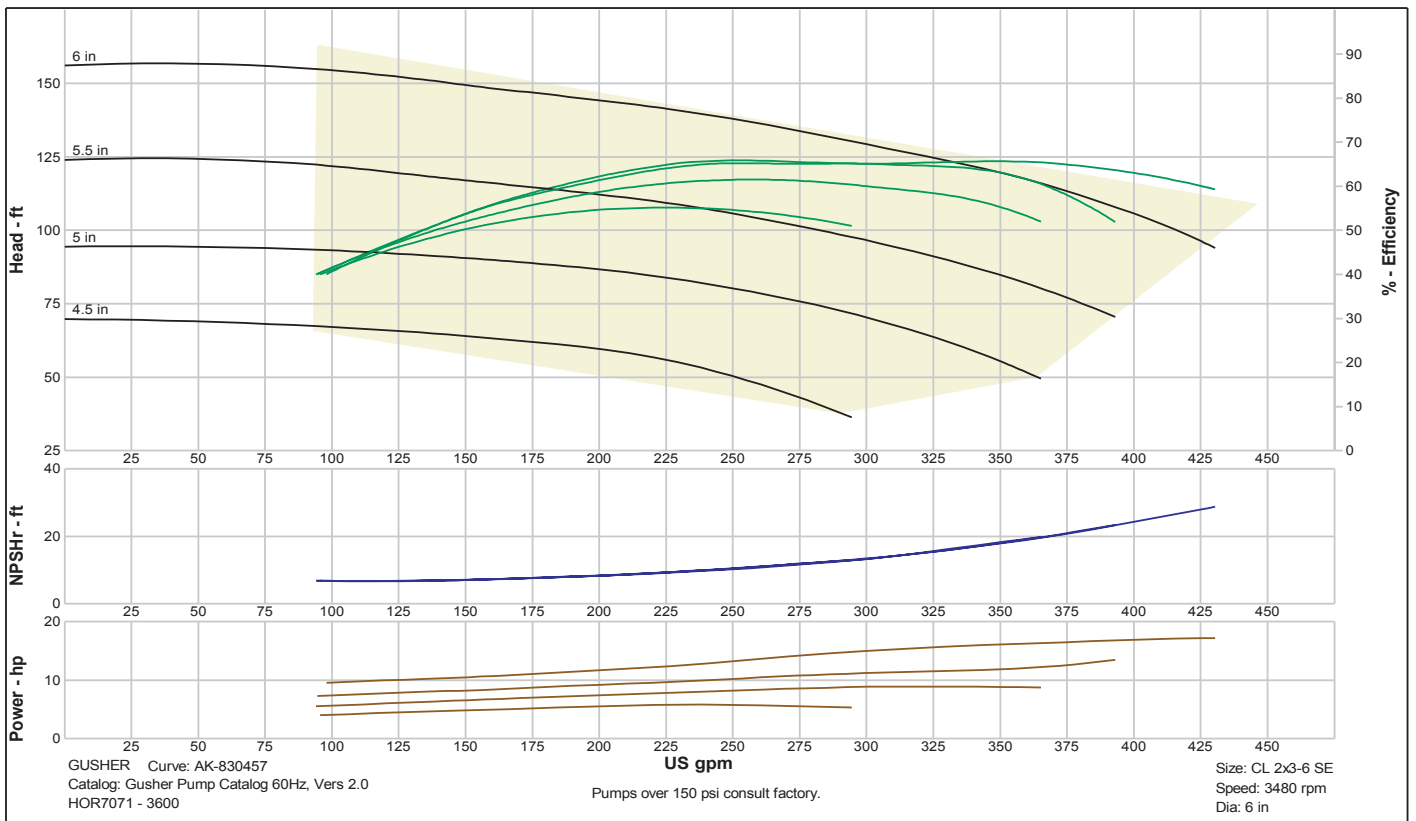

Pump Selection Curves

7071S CL 1x1.5-8SE 1765 rpm

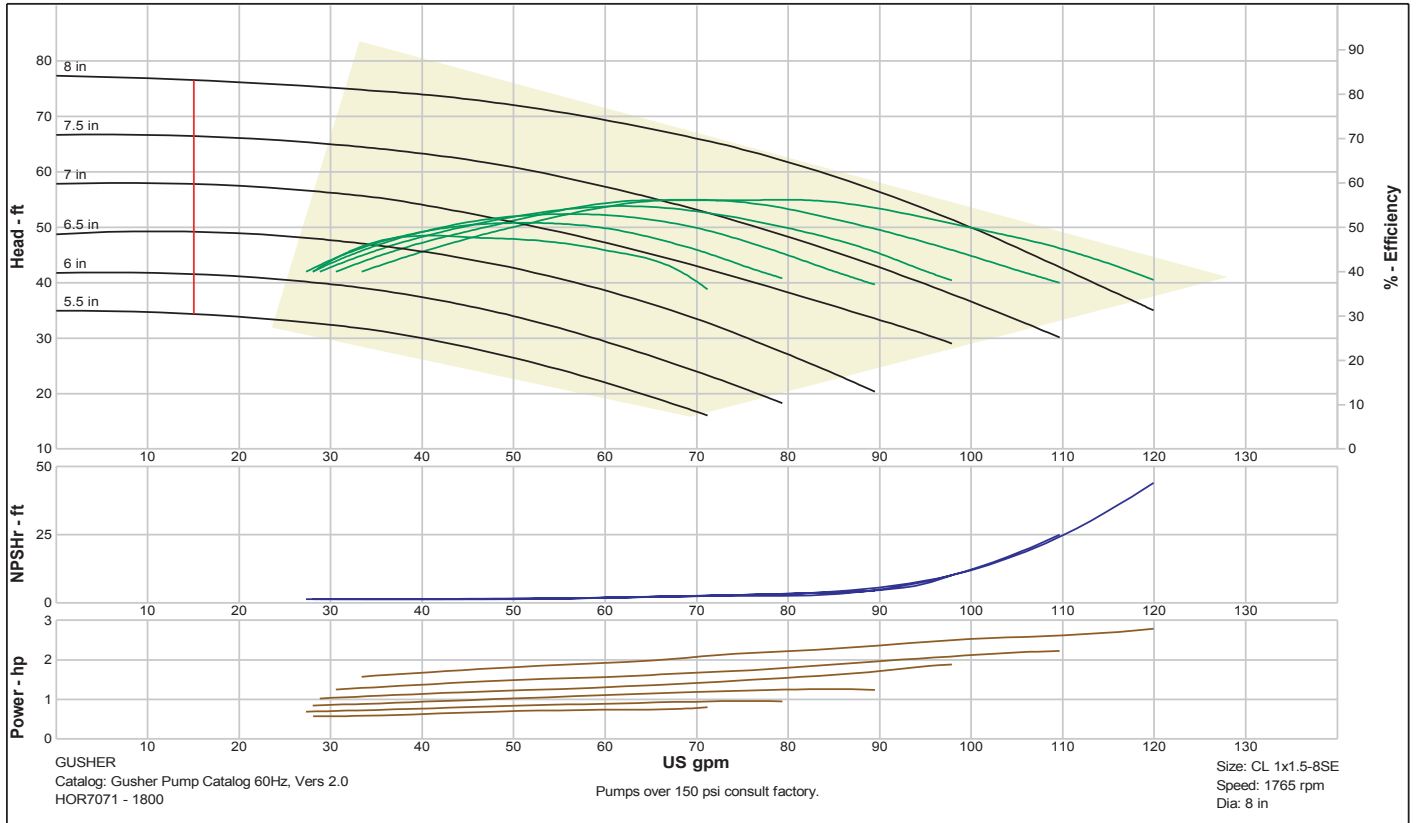

7071S CL 1x1.5-8SE 3480 rpm

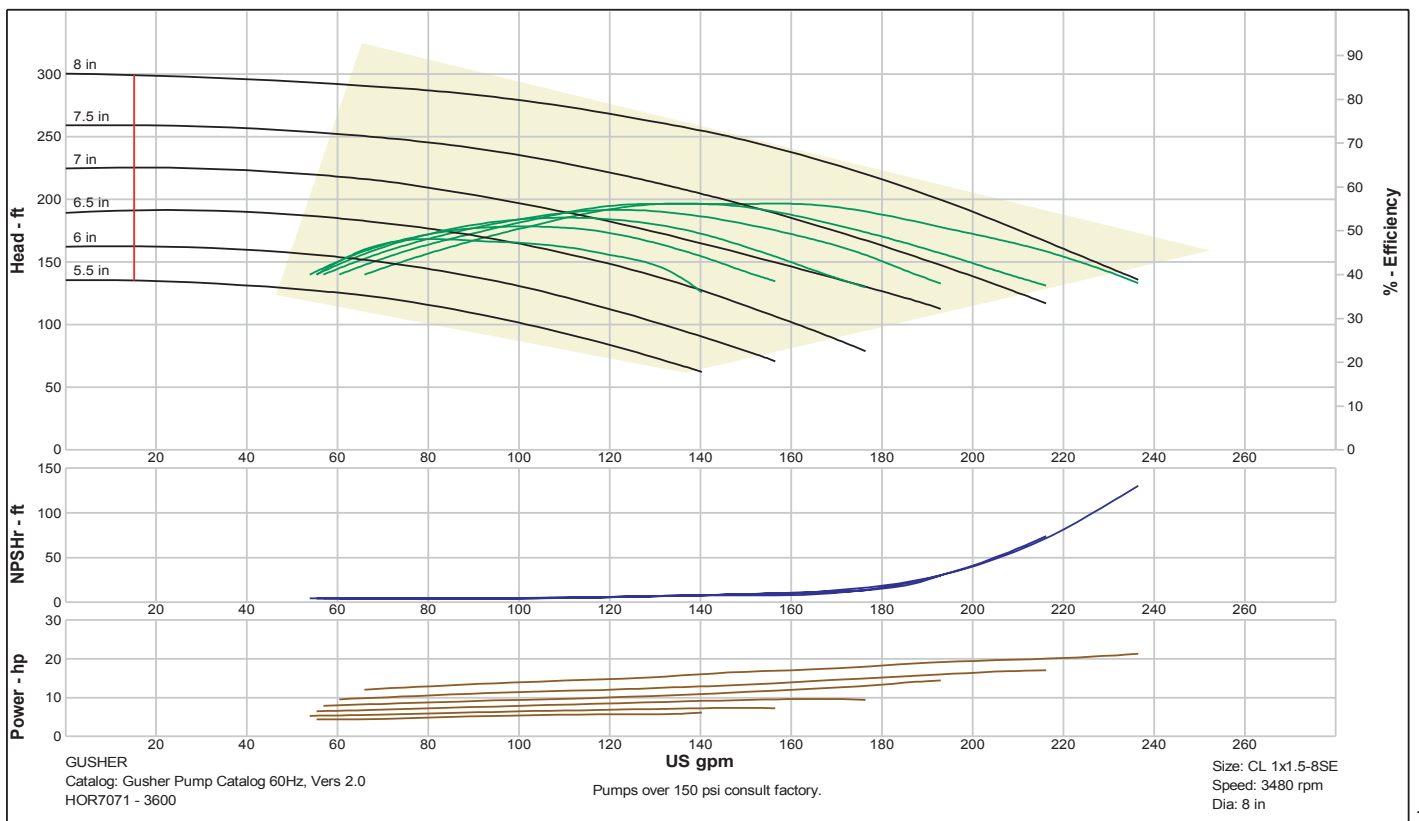

Pump Selection Curves

7071S CL 1.5x3-8SE 1765rpm

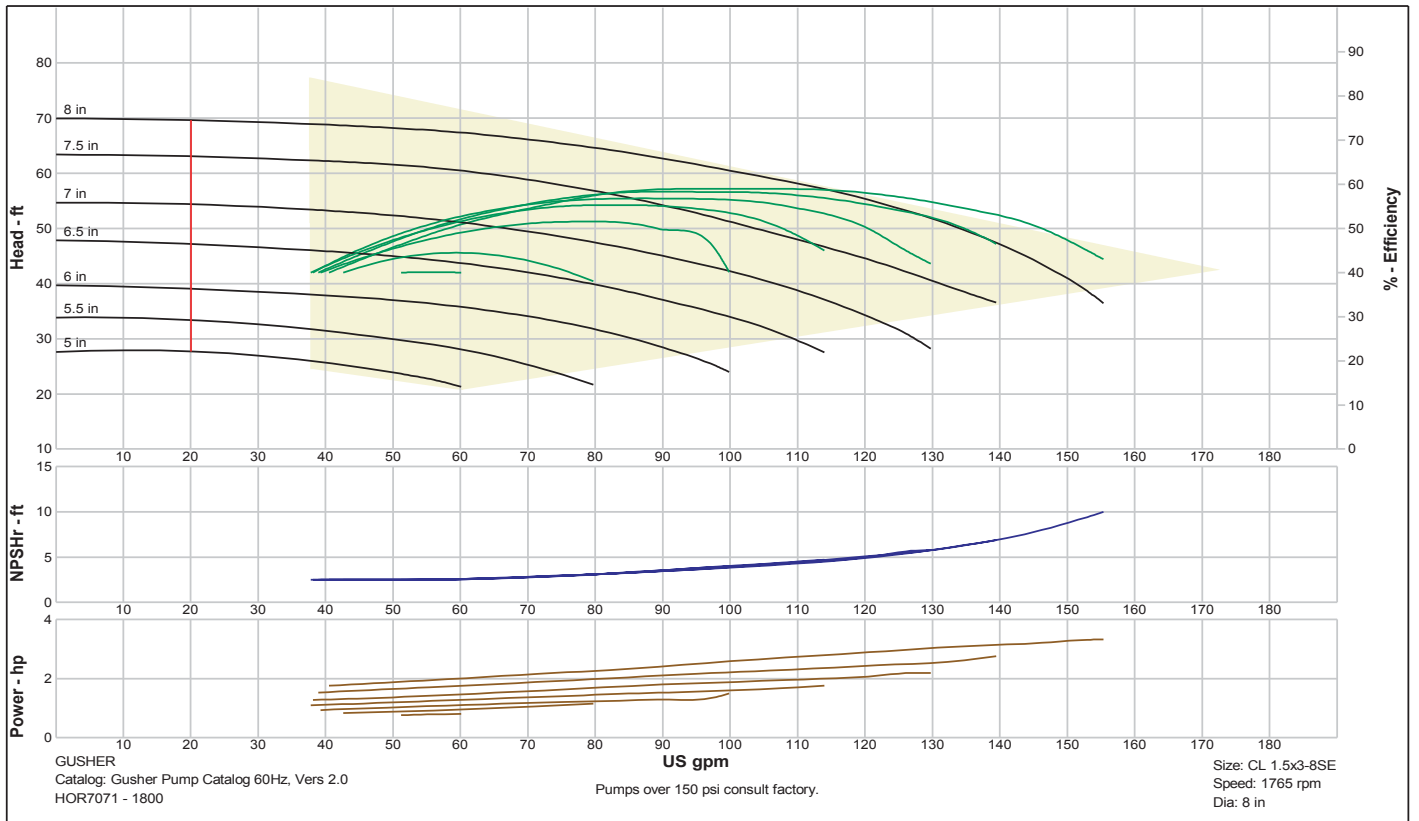

7071S CL 1.5x3-8SE 3480 rpm

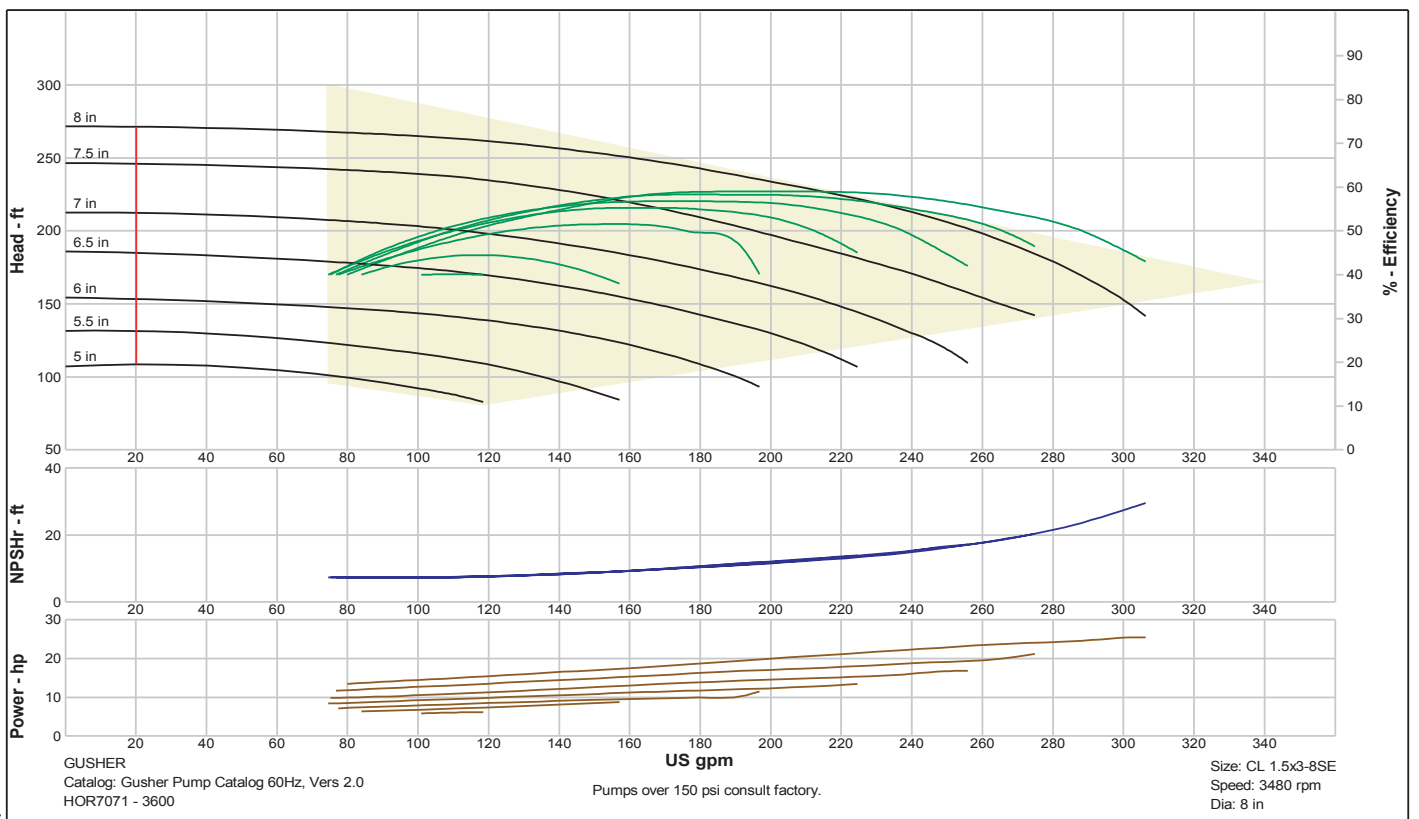

Pump Selection Curves

7071M CL 3x4-7SE 1765 rpm

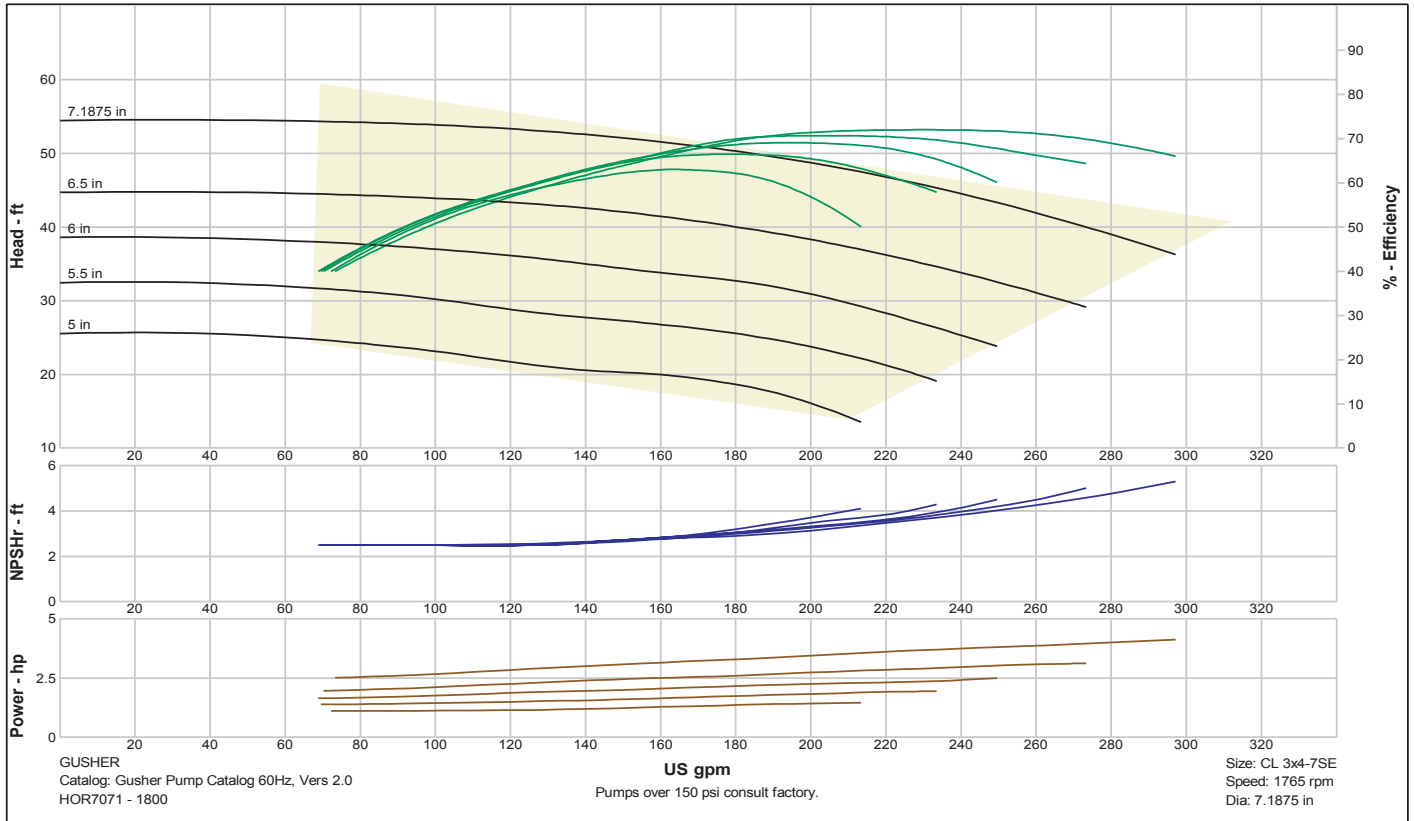

7071M CL 2x3-8SE 1765 rpm

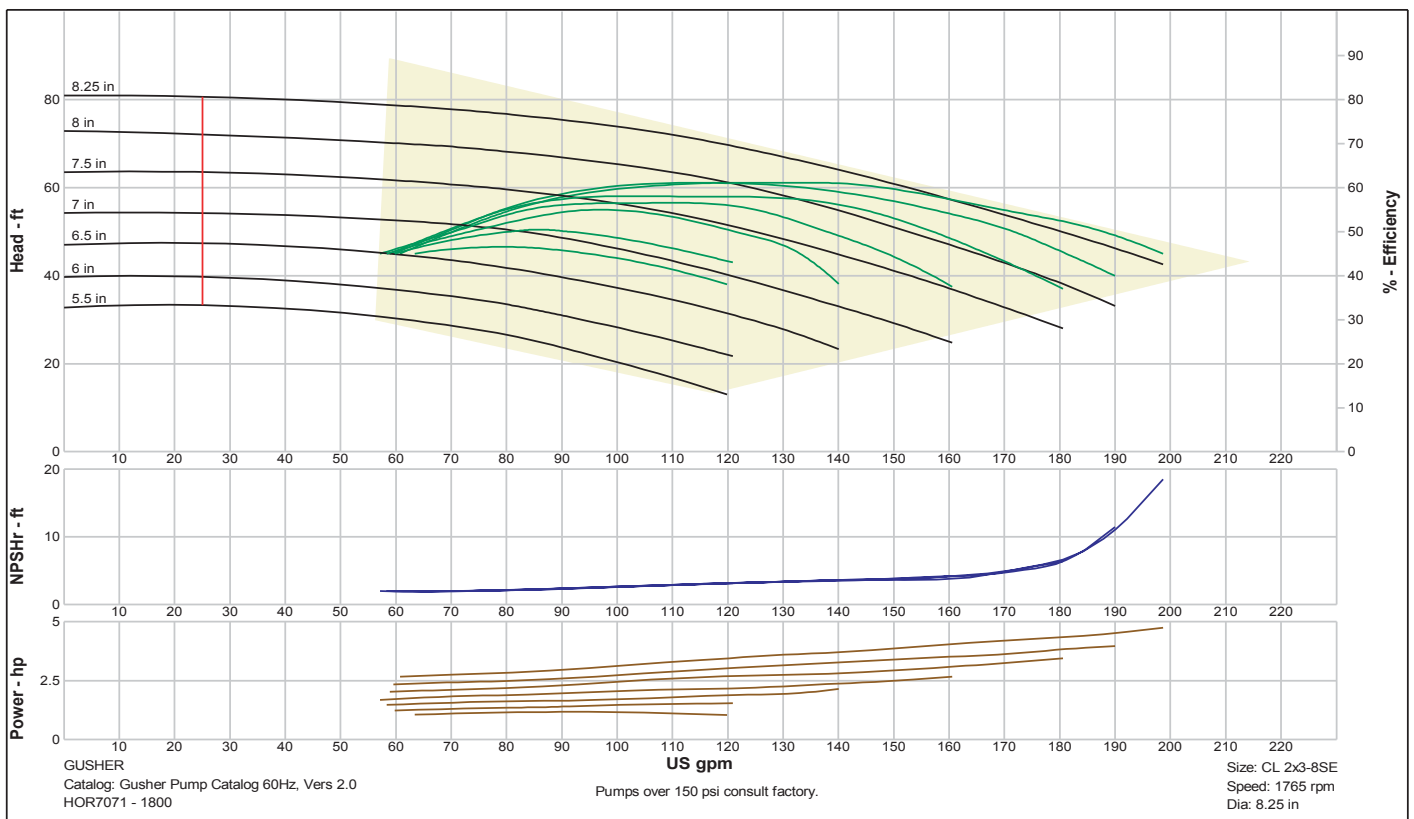

Pump Selection Curves

7071M CL 2x3-8SE 3480 rpm

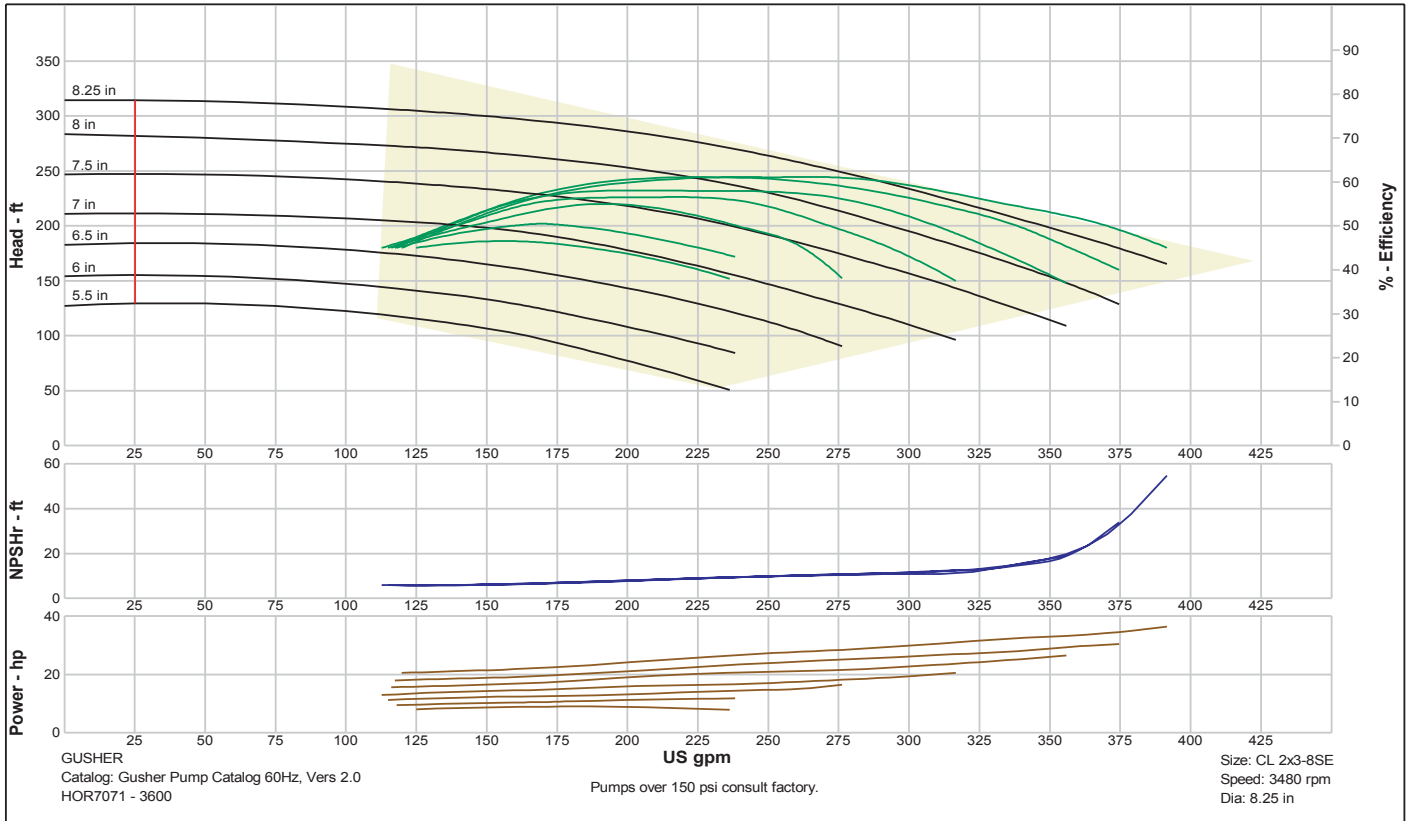

7071M CL 3x4-8SE 1765 rpm

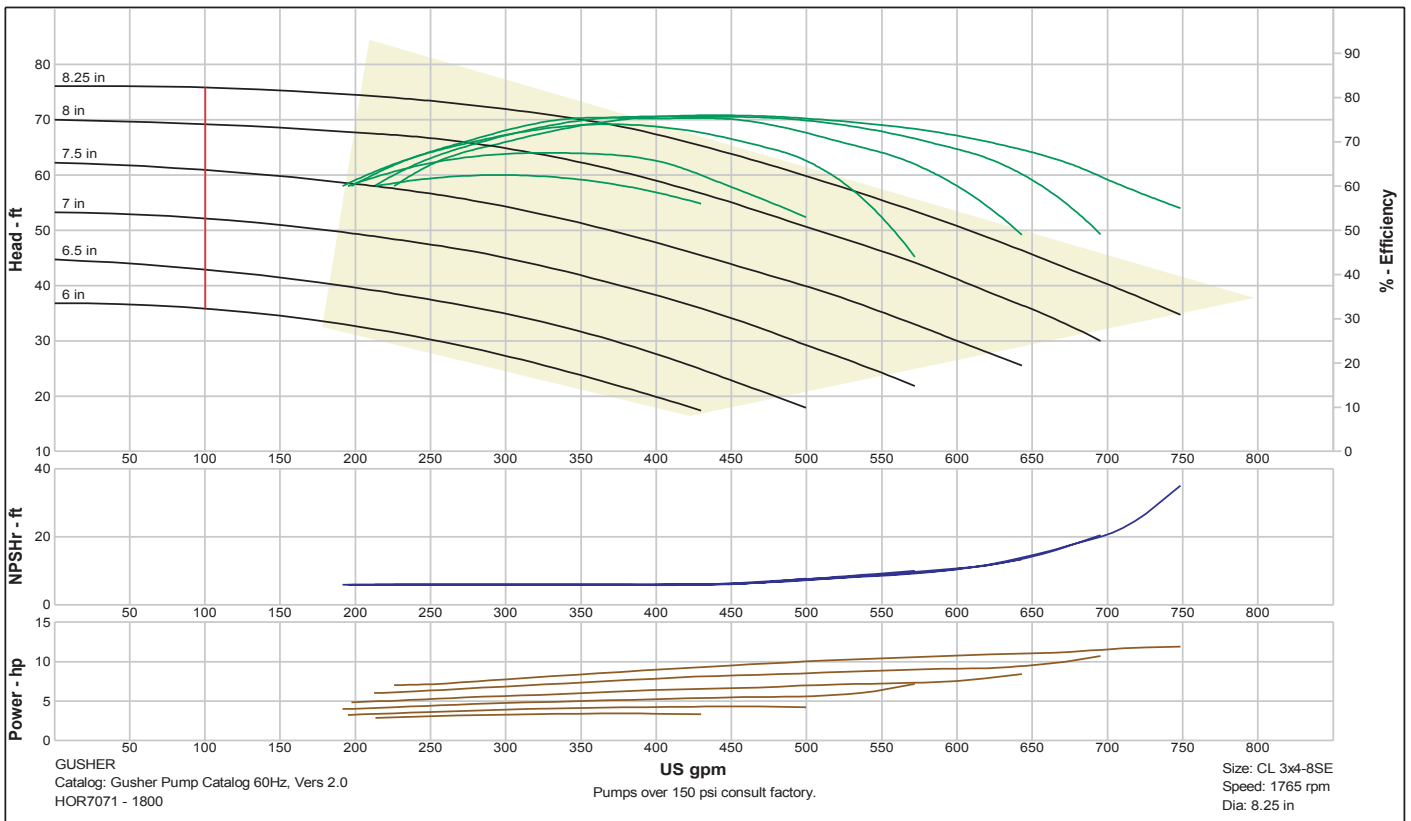

Pump Selection Curves

7071M CL 3x4-8BSE 1765 rpm

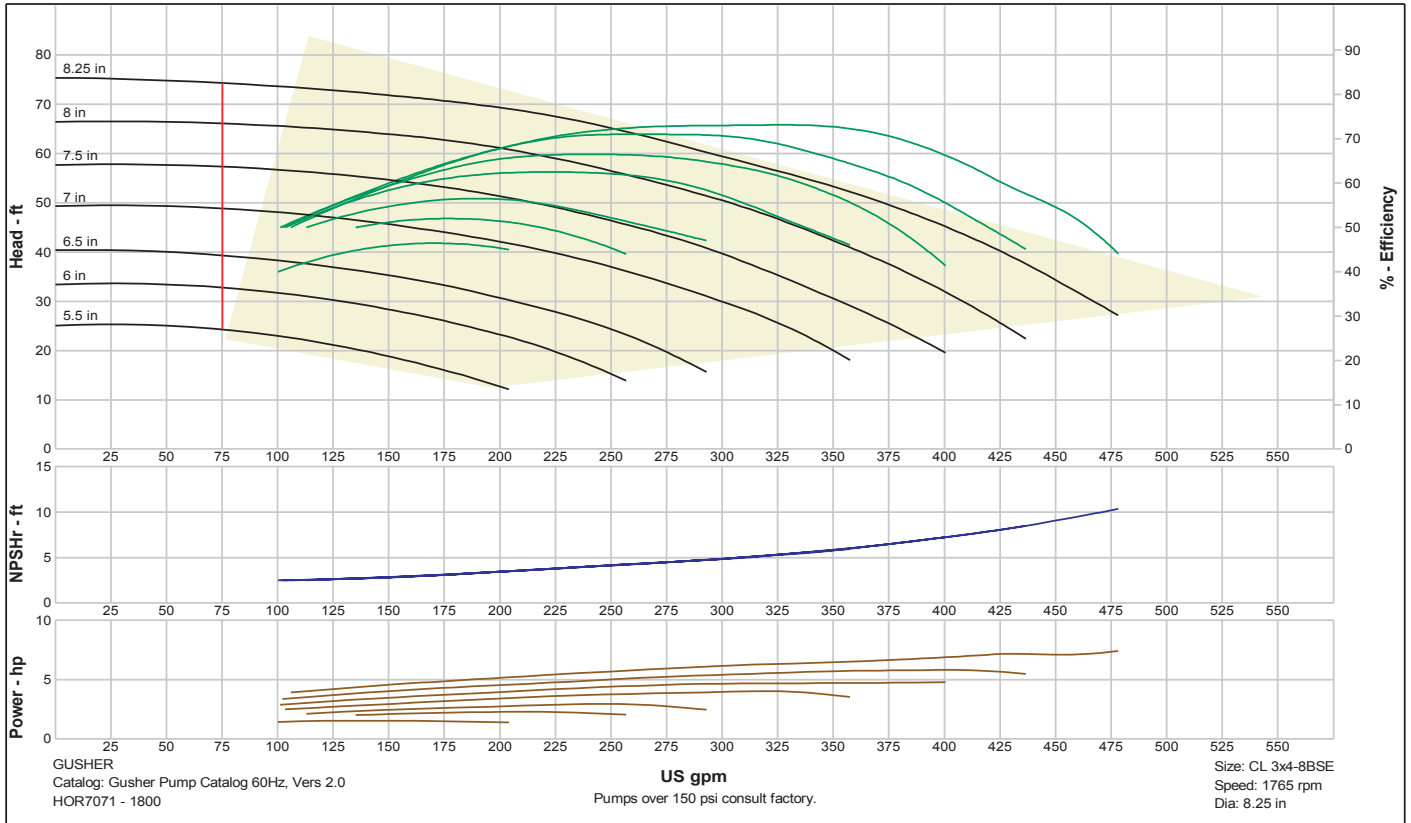

7071M CL 3x4-8BSE 3400 rpm

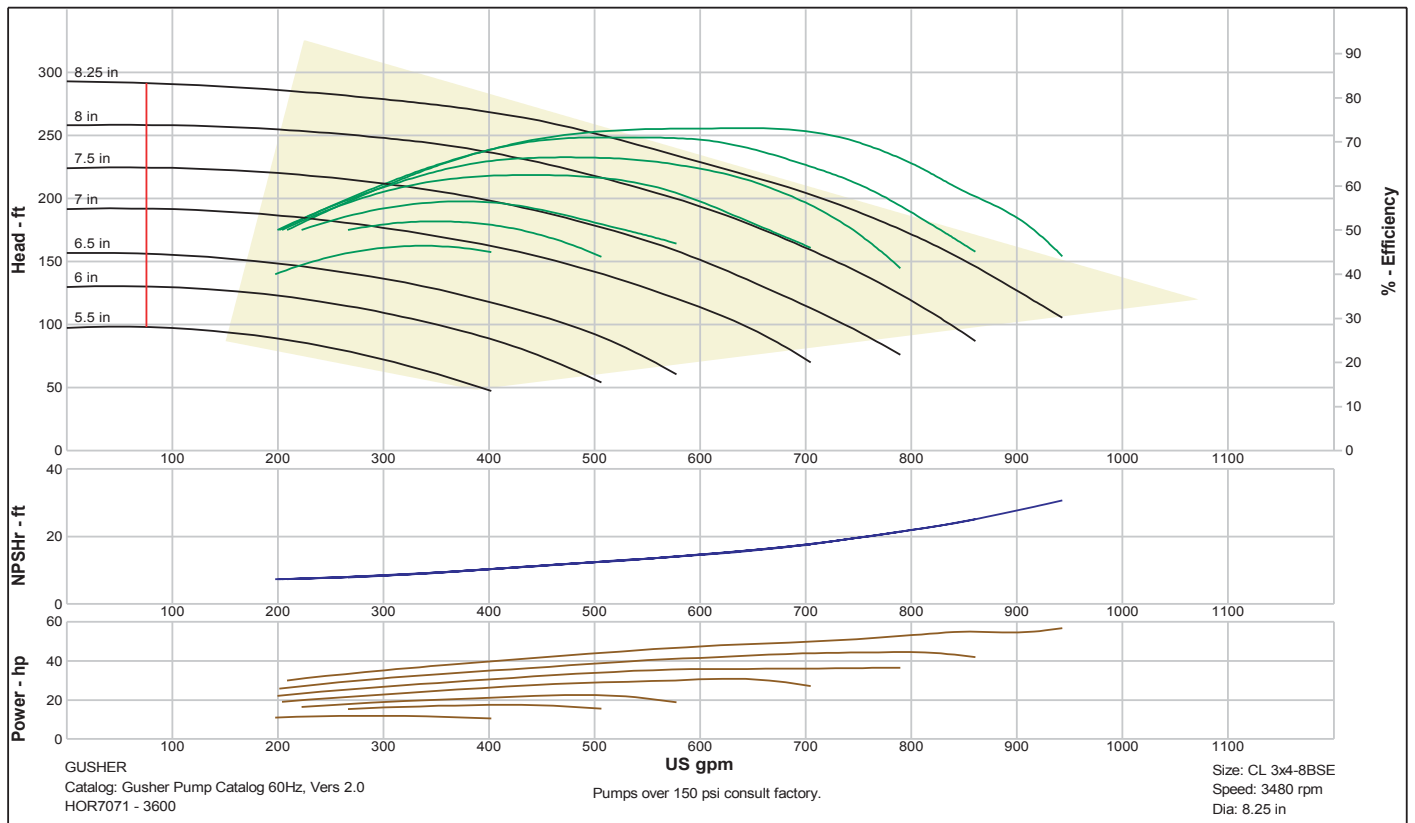

Pump Selection Curves

7071M CL 5x6-9SE 1765 rpm

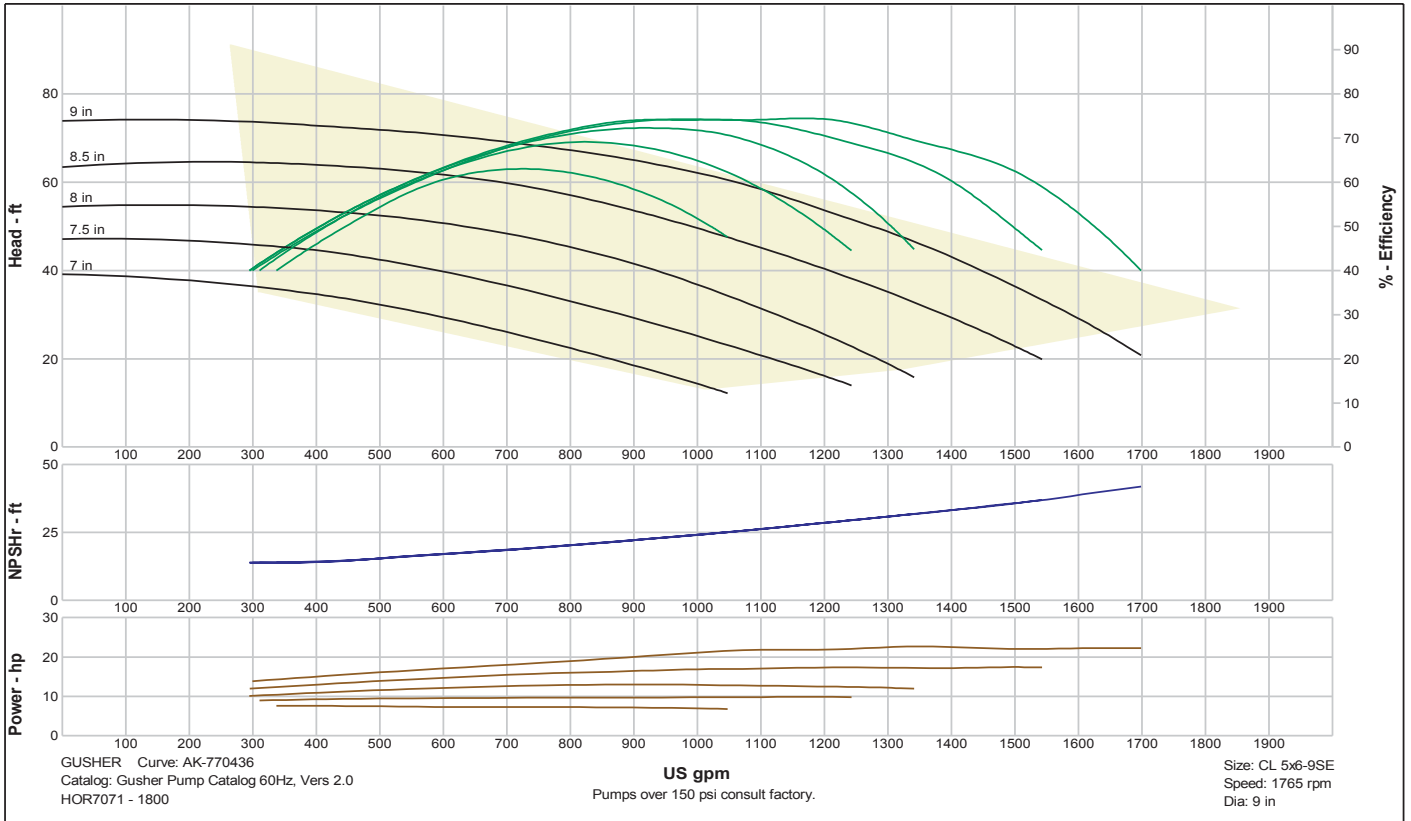

7071M CL 1x2-10SE 1765 rpm

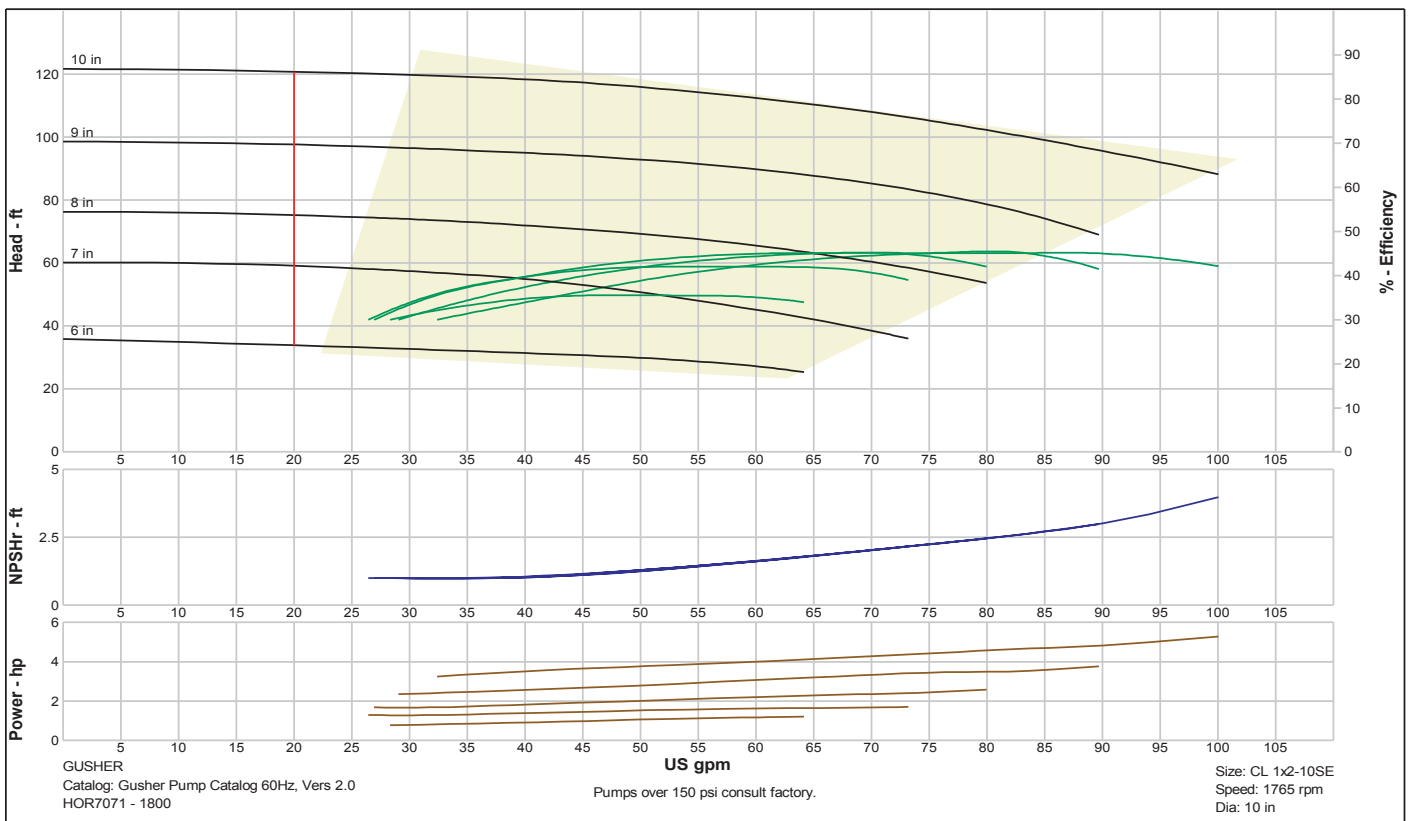

Pump Selection Curves

7071M CL 1x2-10SE 3480 rpm

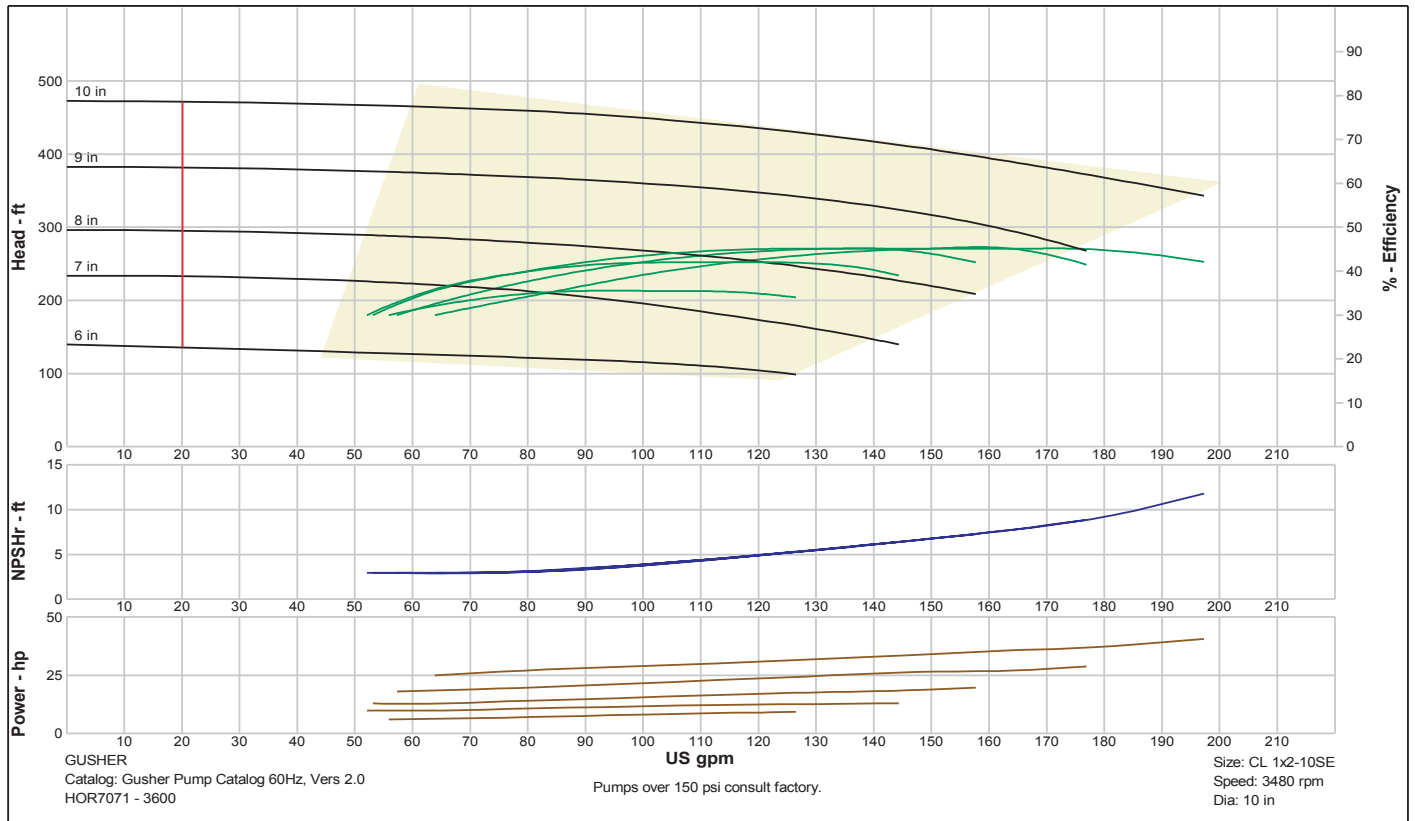

7071M CL 1.5x3-10SE 1765 rpm

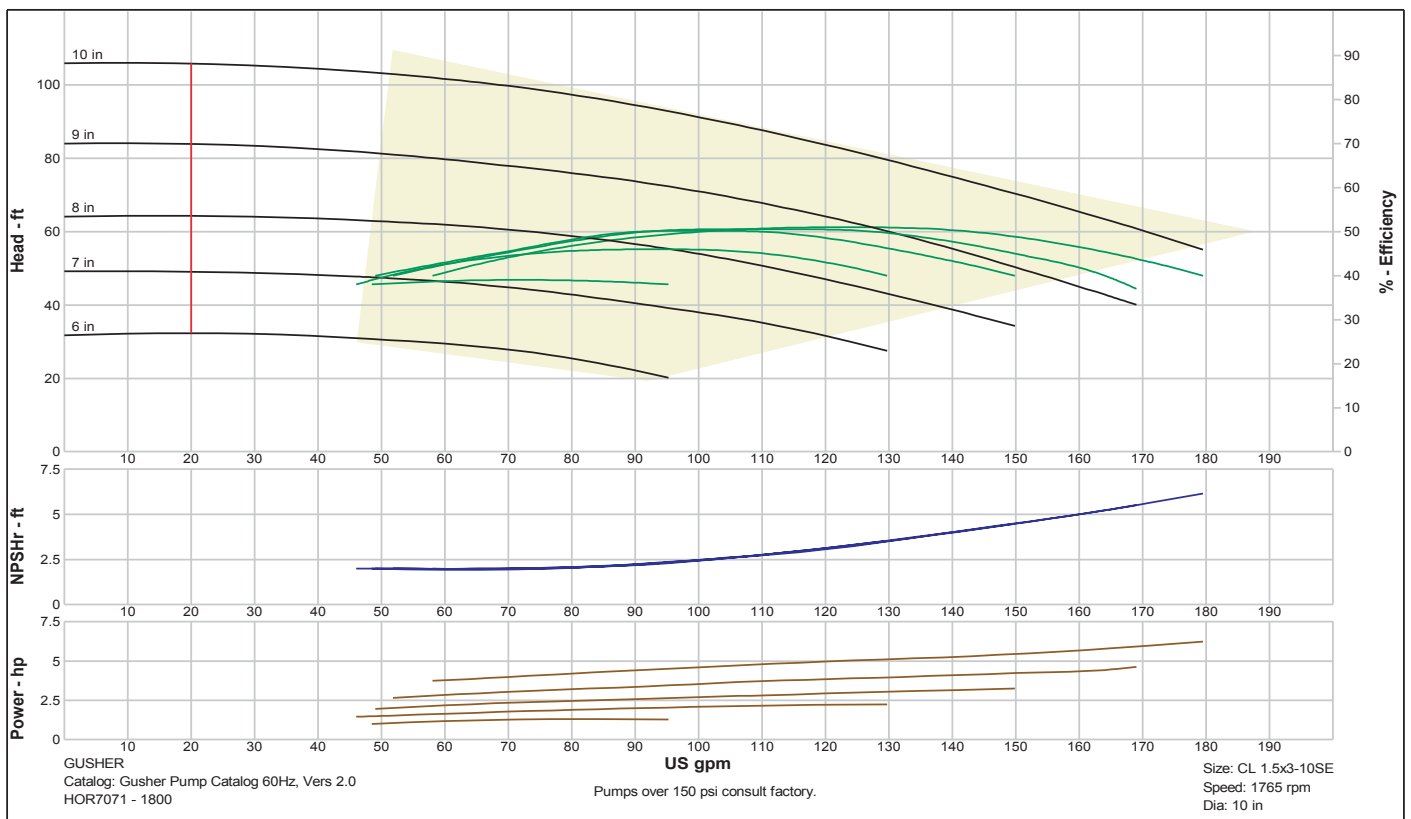

Pump Selection Curves

7071M CL 1.5x3-10SE 3480 rpm

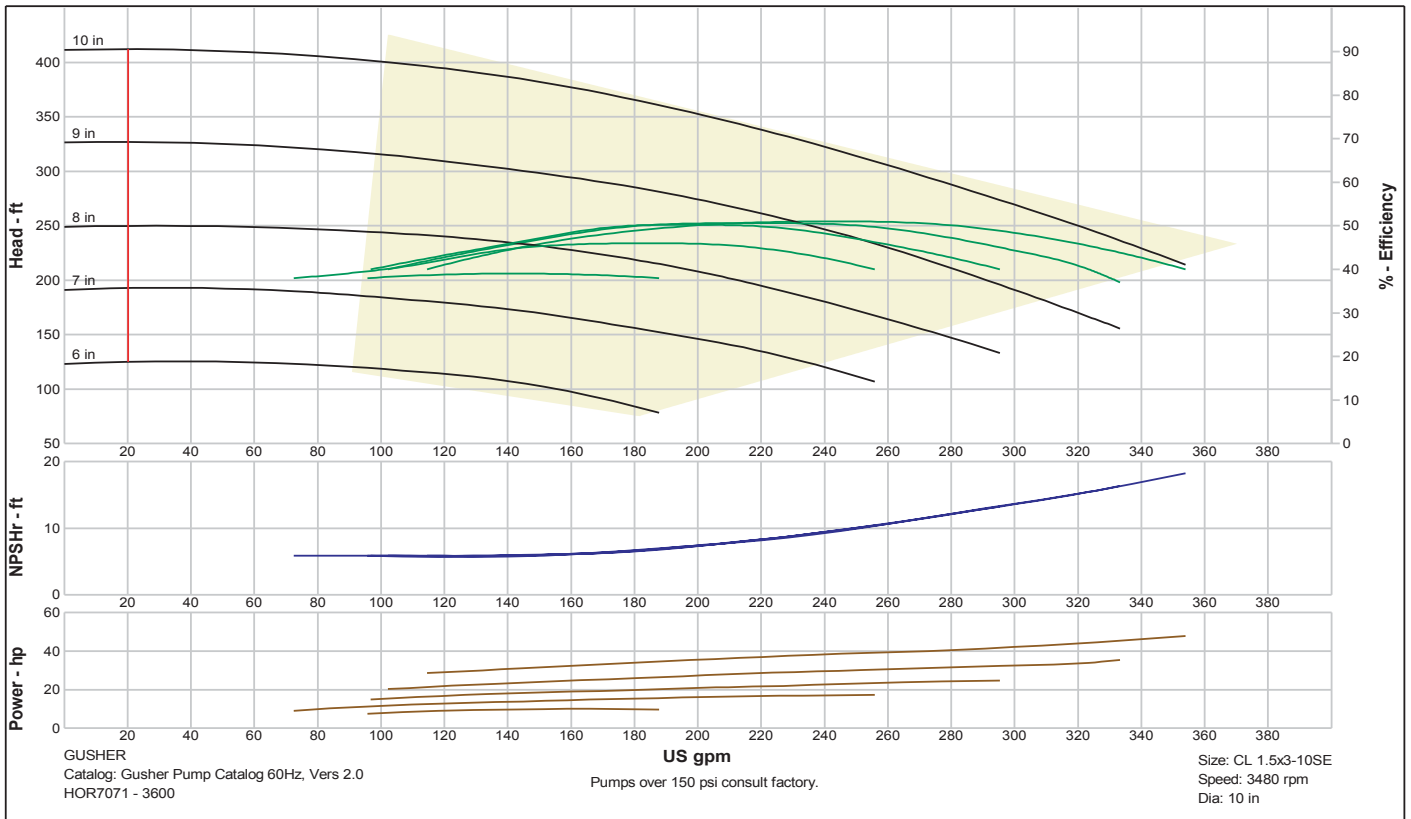

7071M CL 2x3-10SE 1765 rpm

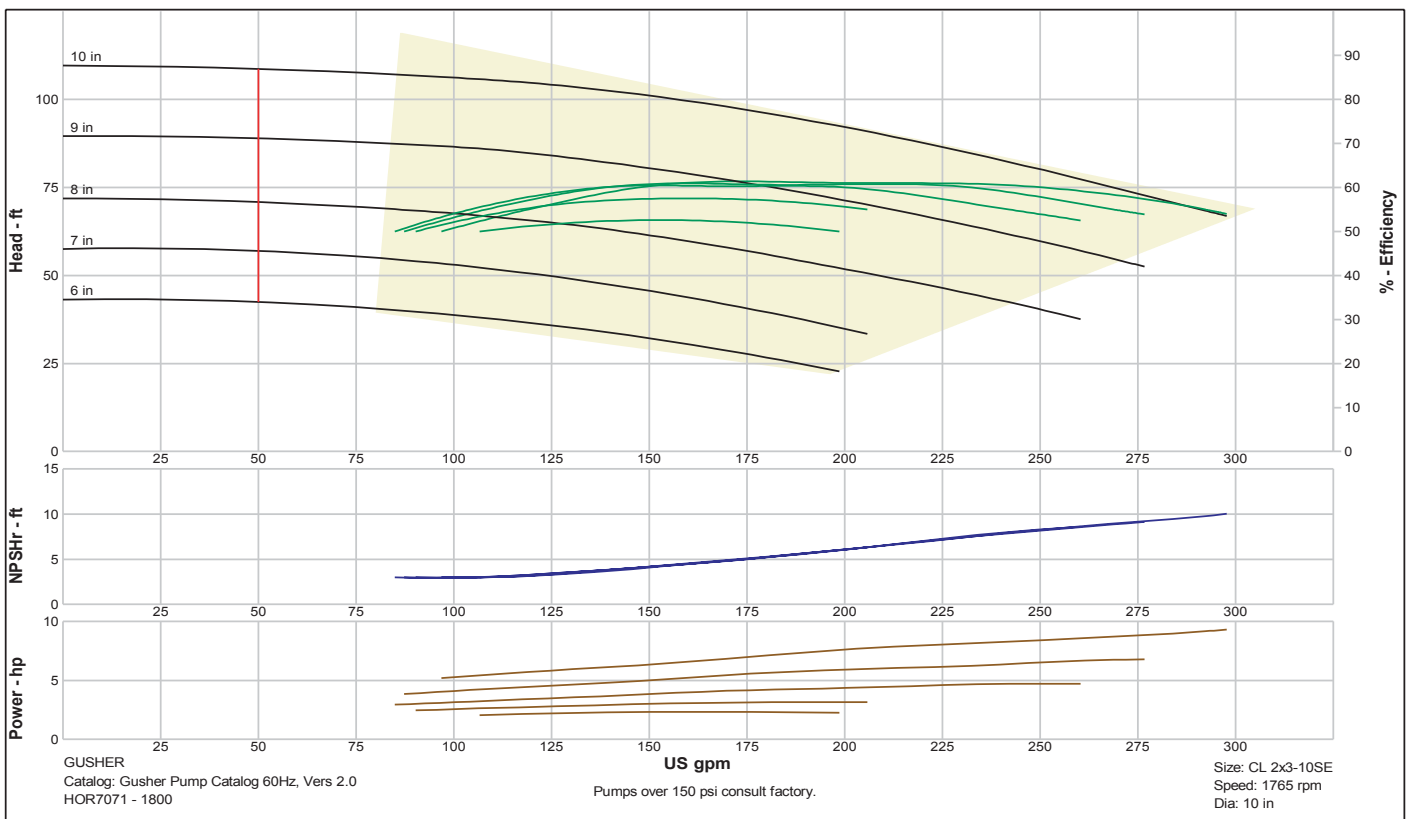

Pump Selection Curves

7071M CL 2x3-10SE 3480 rpm

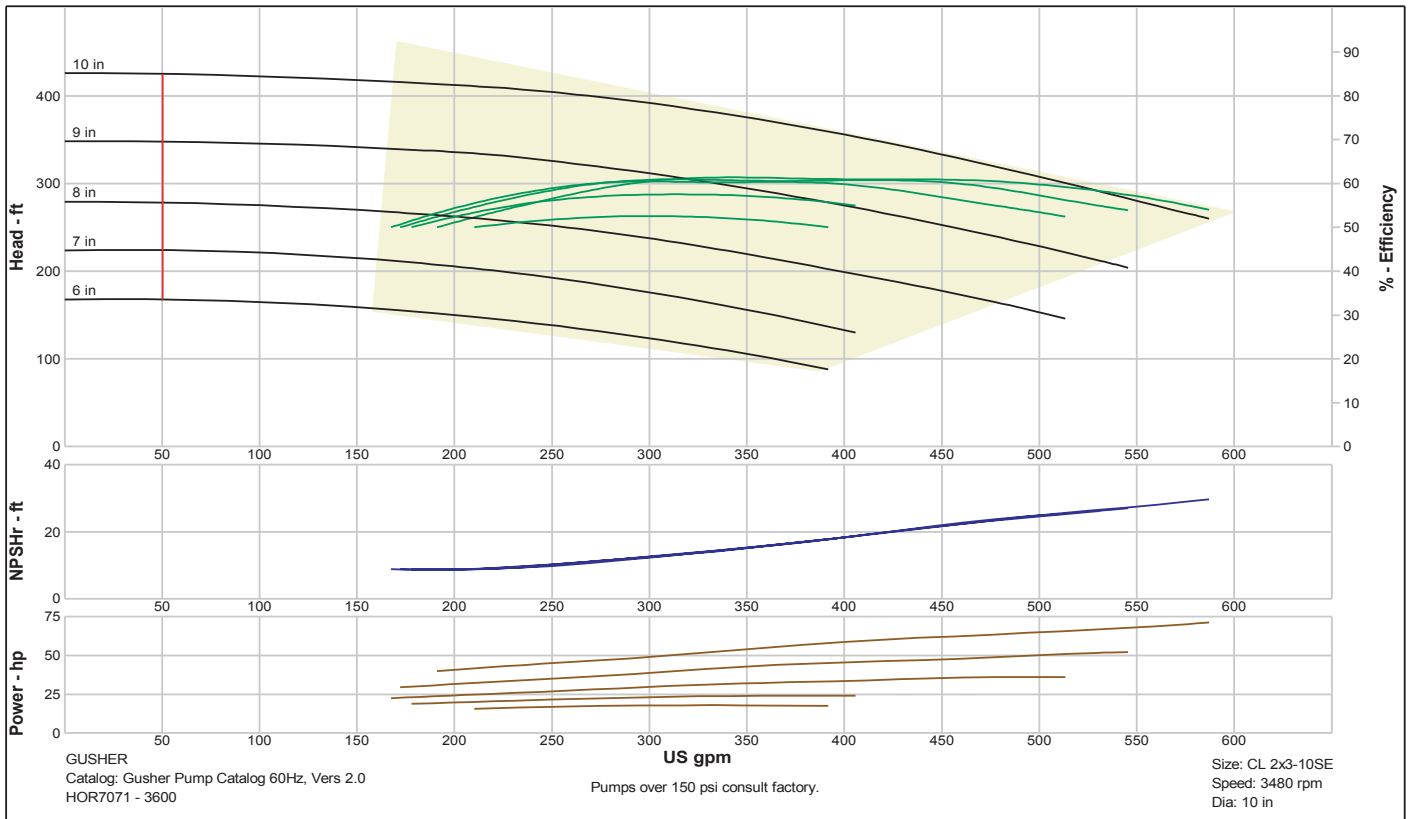

7071M CL 3x4-10SE 1765 rpm

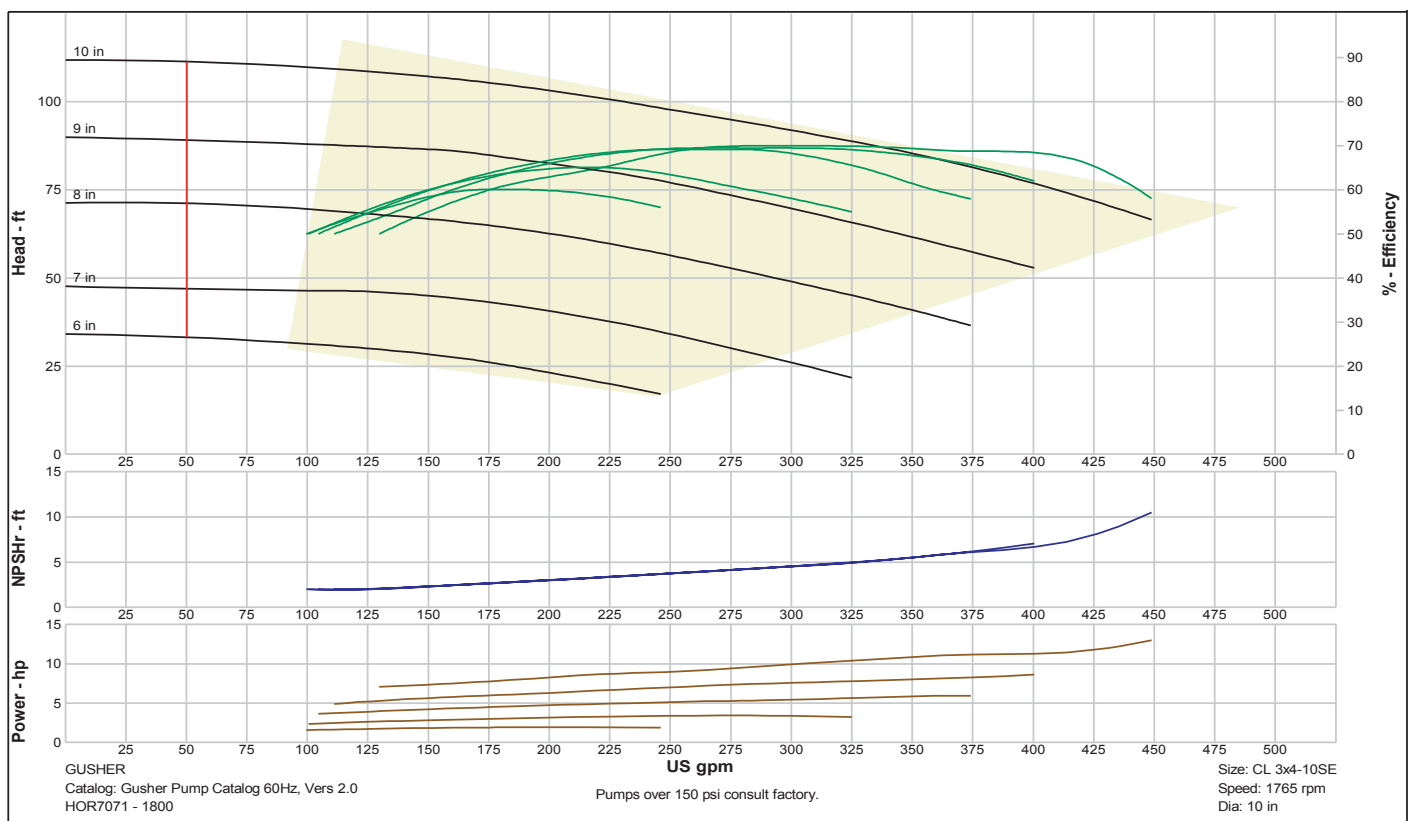

Pump Selection Curves

7071M CL 3x4-10SE 3480 rpm

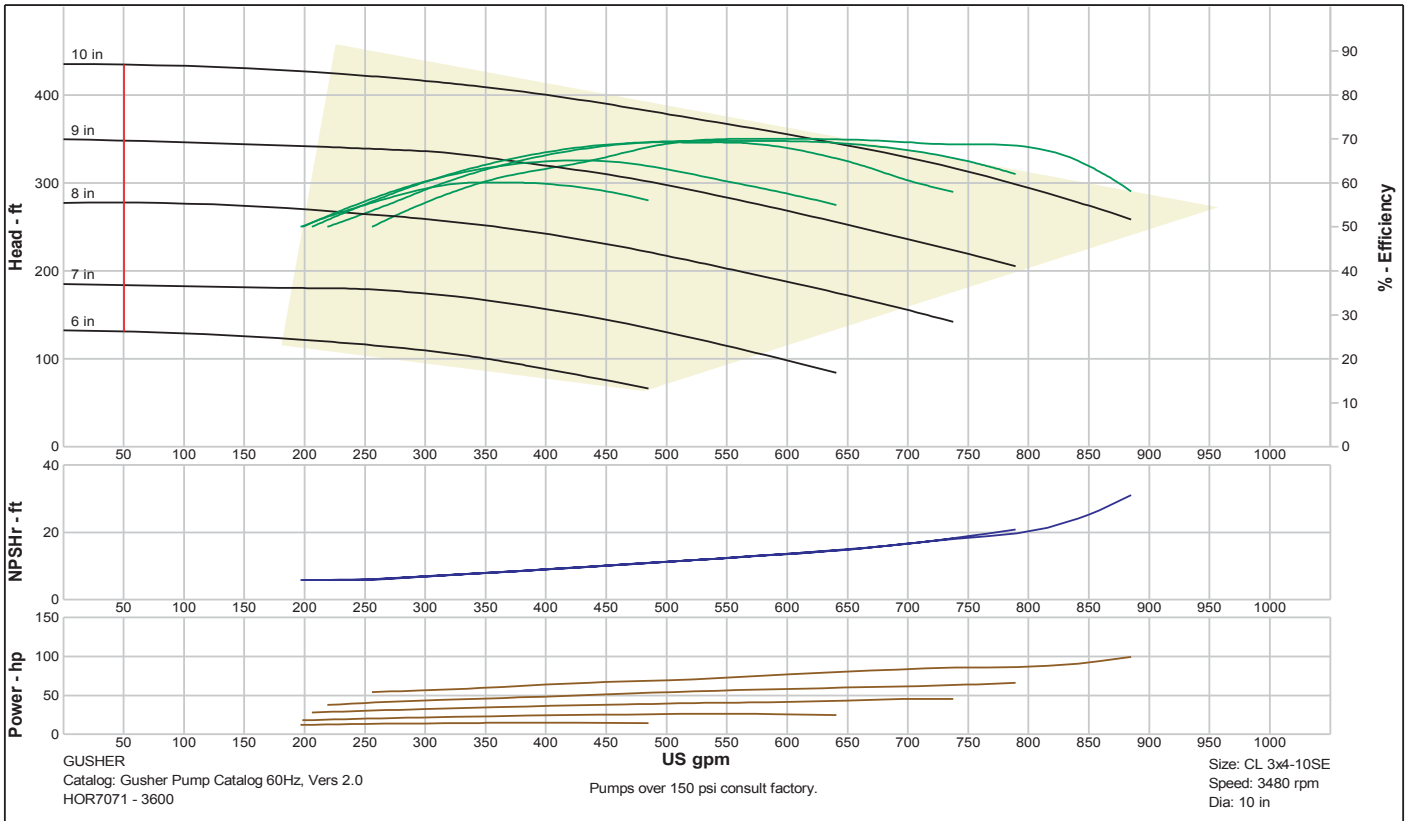

7071M CL 3x4-10BSE 1765 rpm

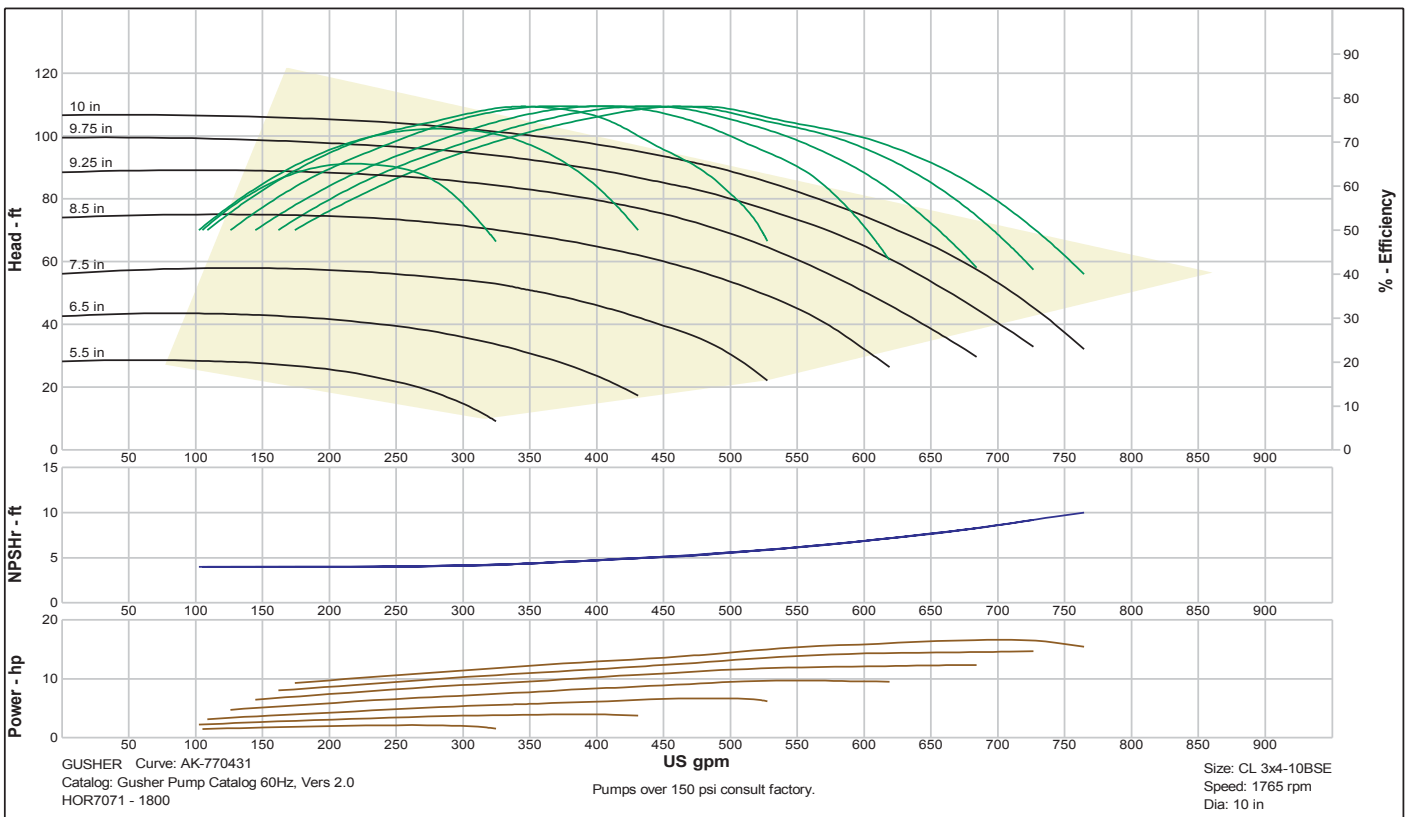

Pump Selection Curves

7071M CL 4x6-10SE 1765 rpm

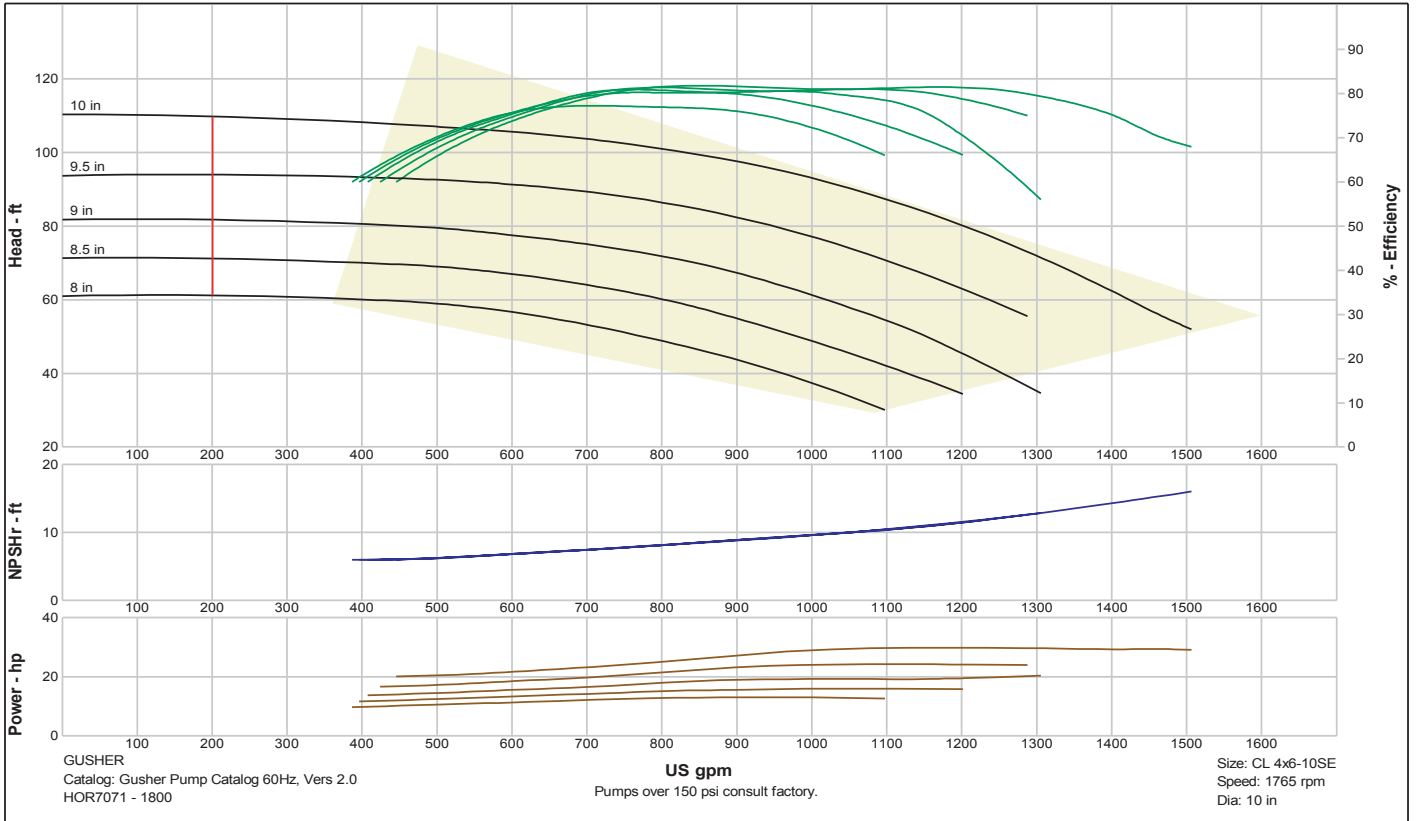

7071M CL 4x6-10BSE 1765 rpm

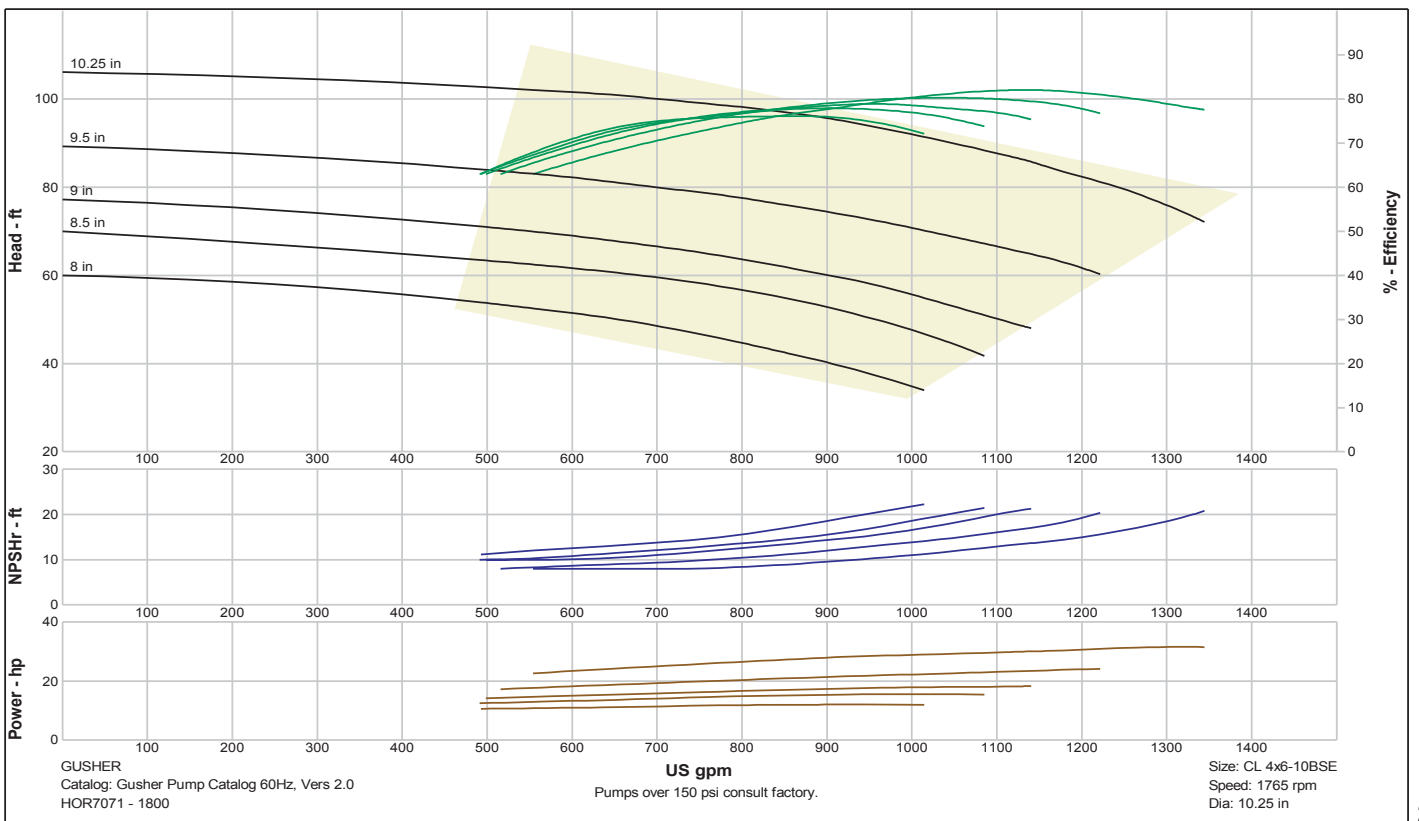

Pump Selection Curves

7071M CL 4x6-10BSE 3480 rpm

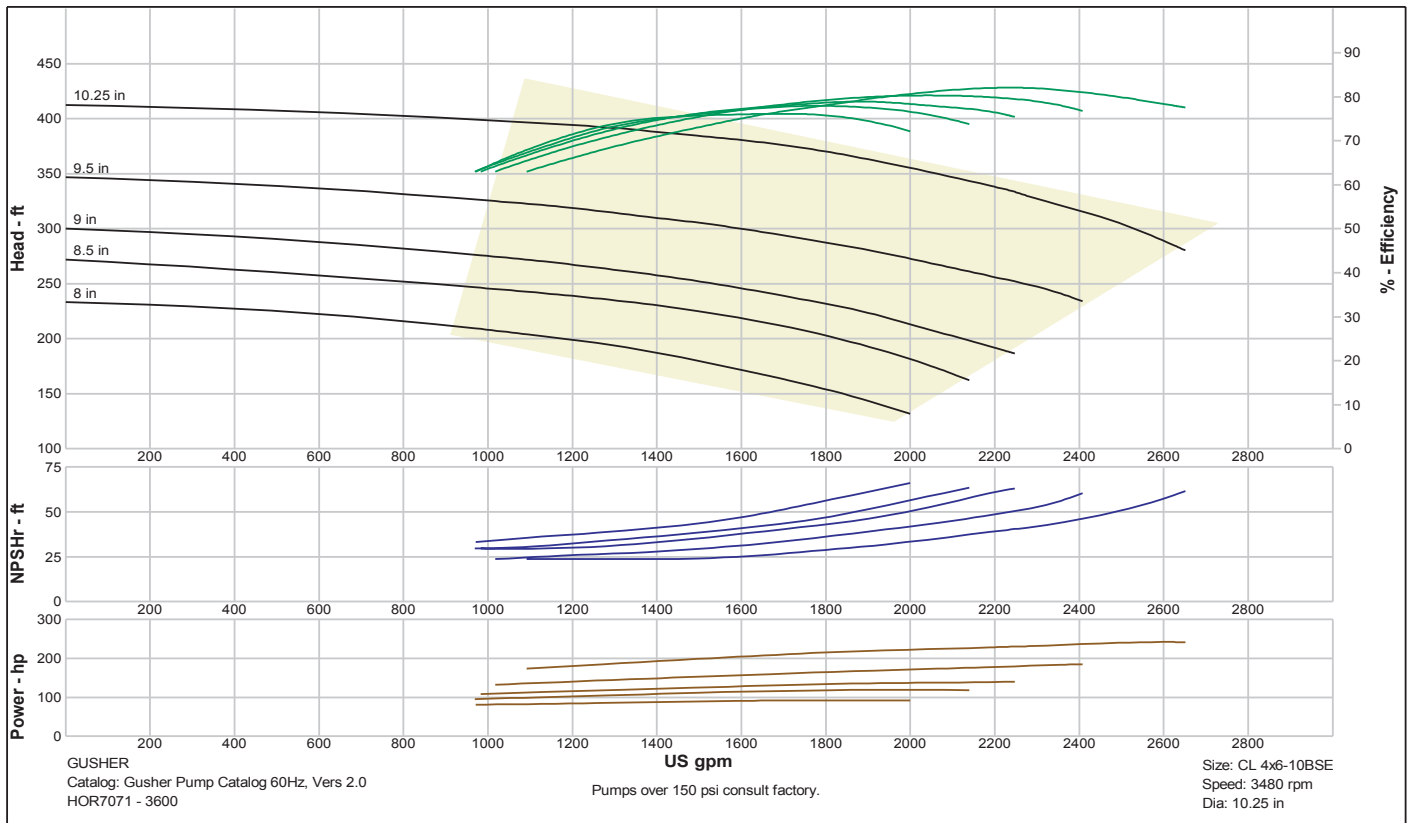

7071M CL 4x5-11SE 1765 rpm

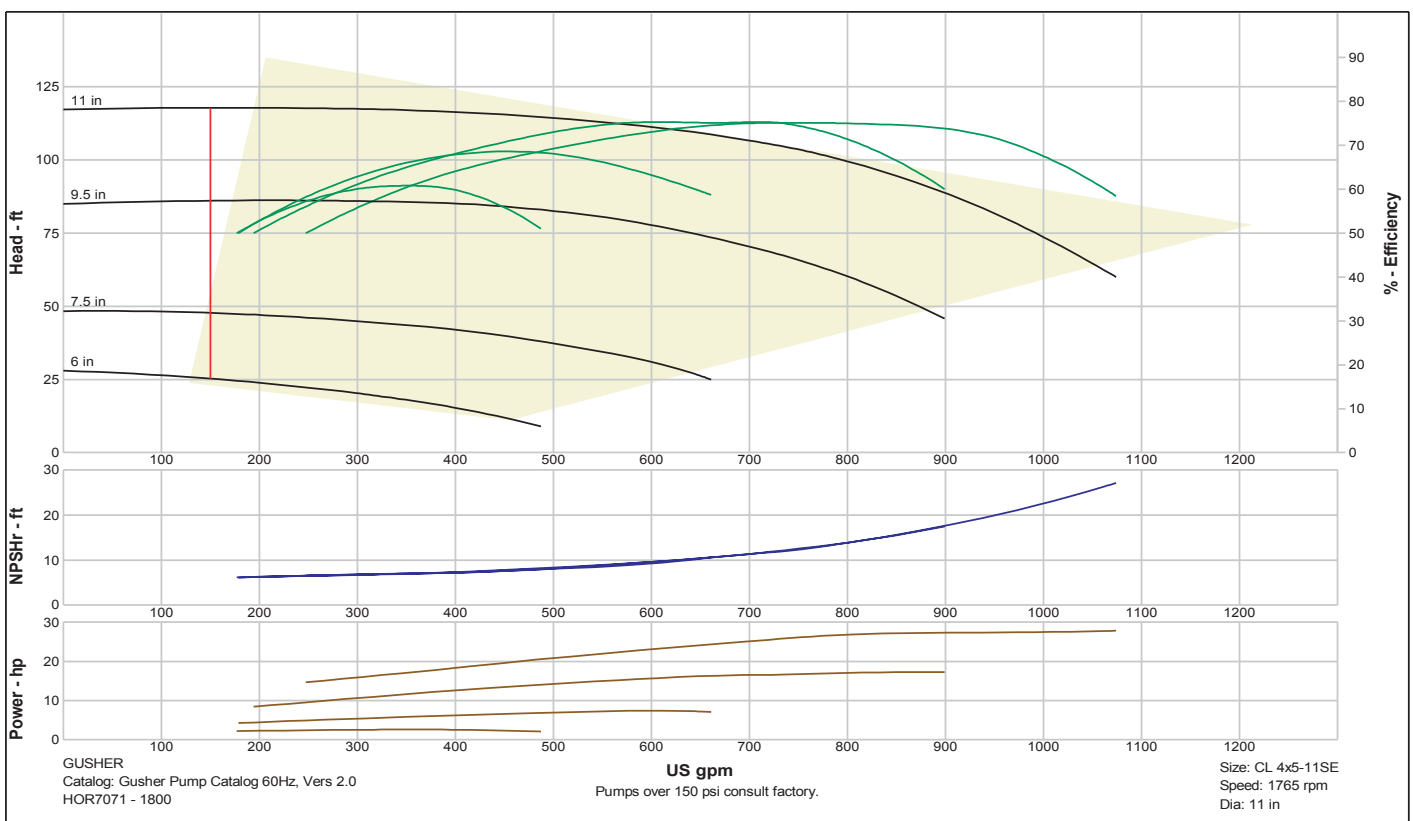

Pump Selection Curves

7071M CL 6x8-11SE 1765 rpm

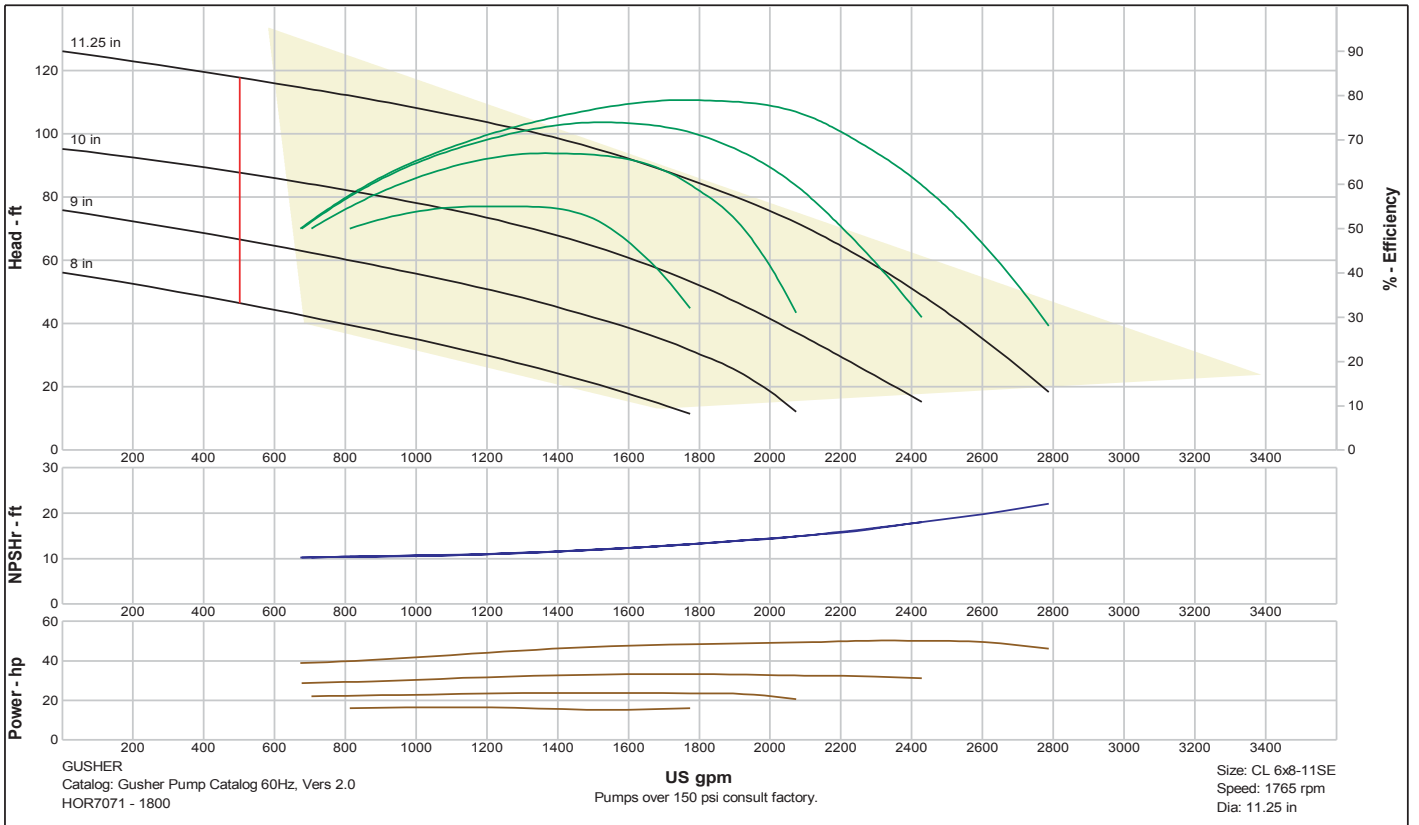

7071M CL 1.5x3-13SE 1765 rpm

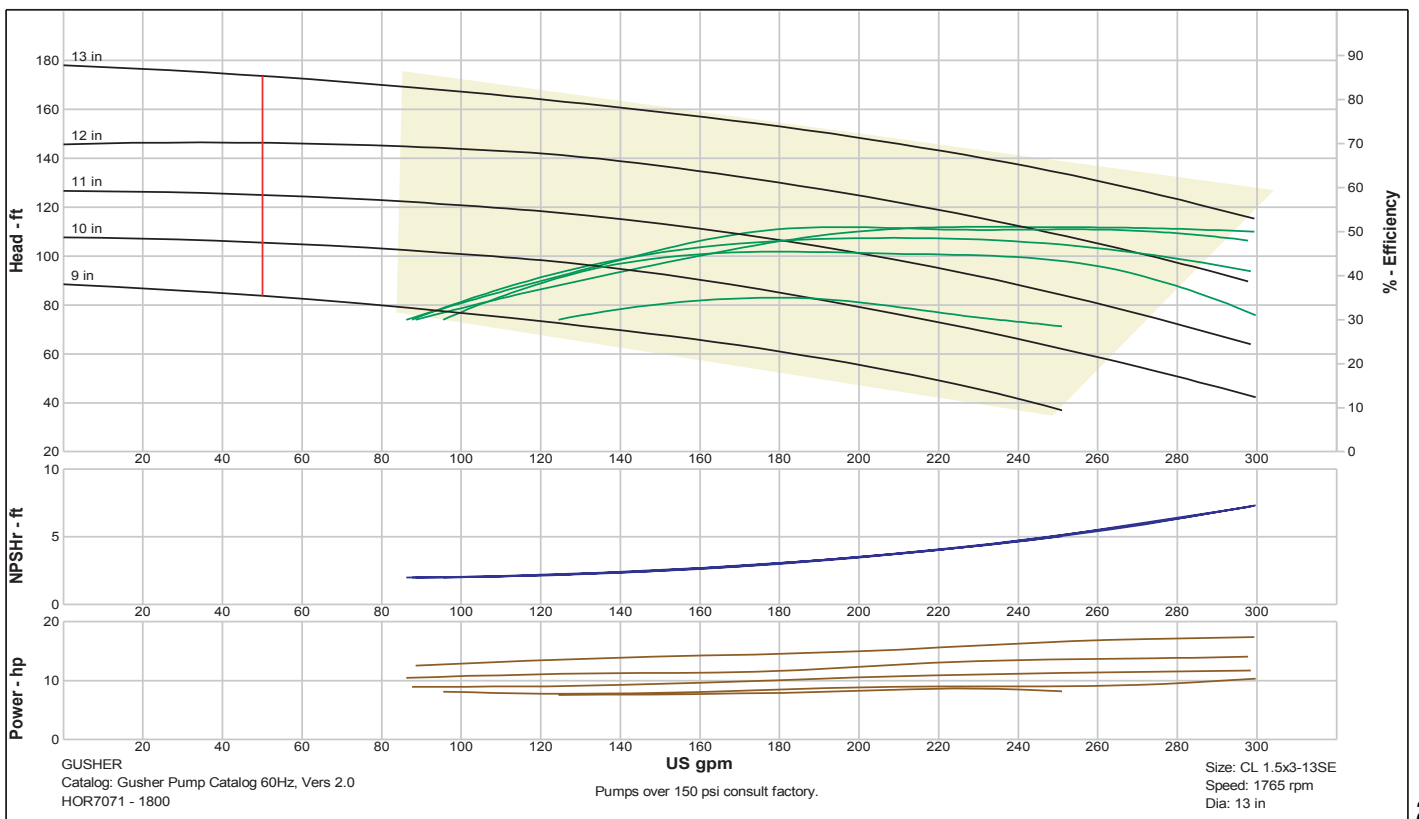

Pump Selection Curves

7071M CL 1.5x3-13SE 3480 rpm

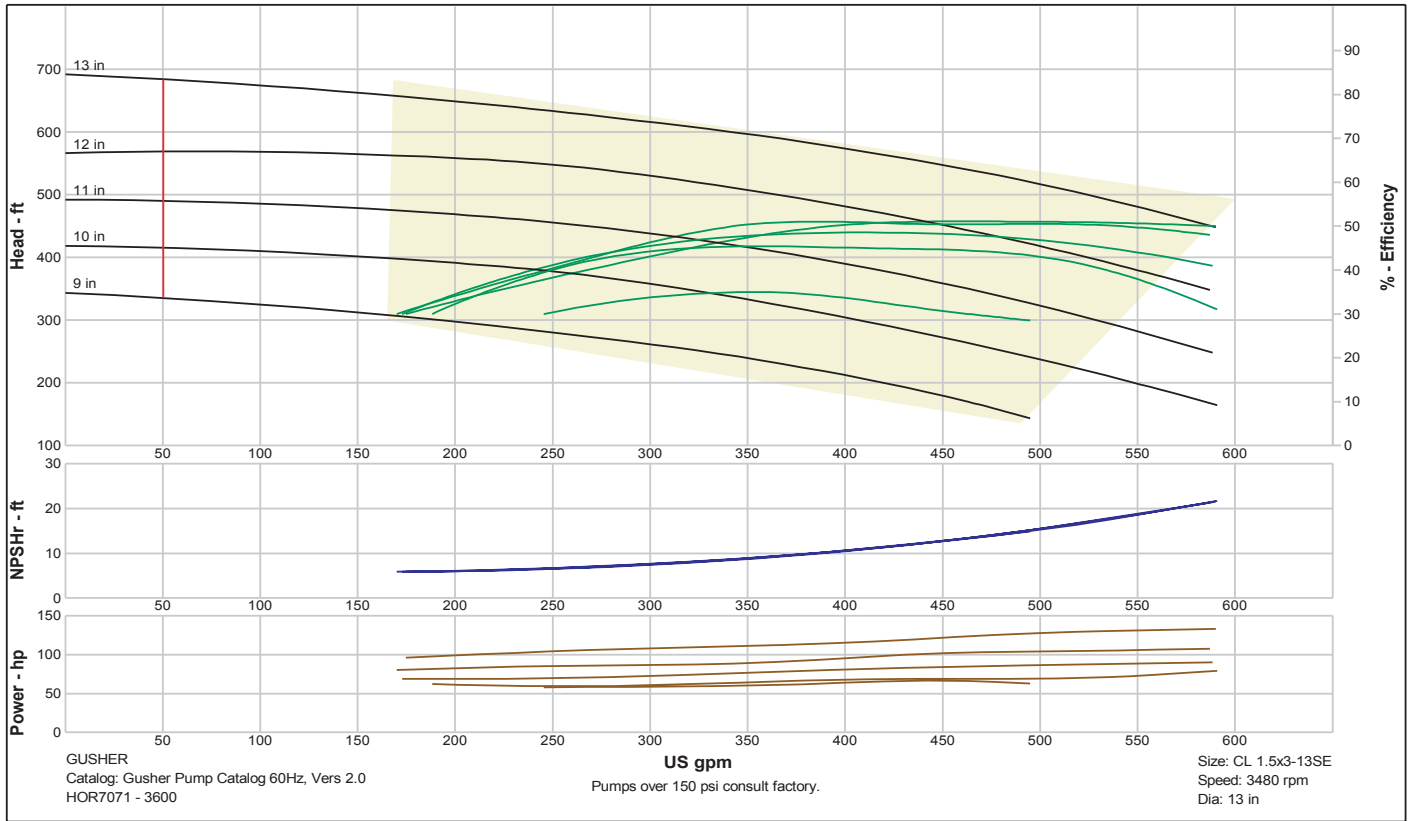

7071M CL 1.5x3-13SE 3480 rpm

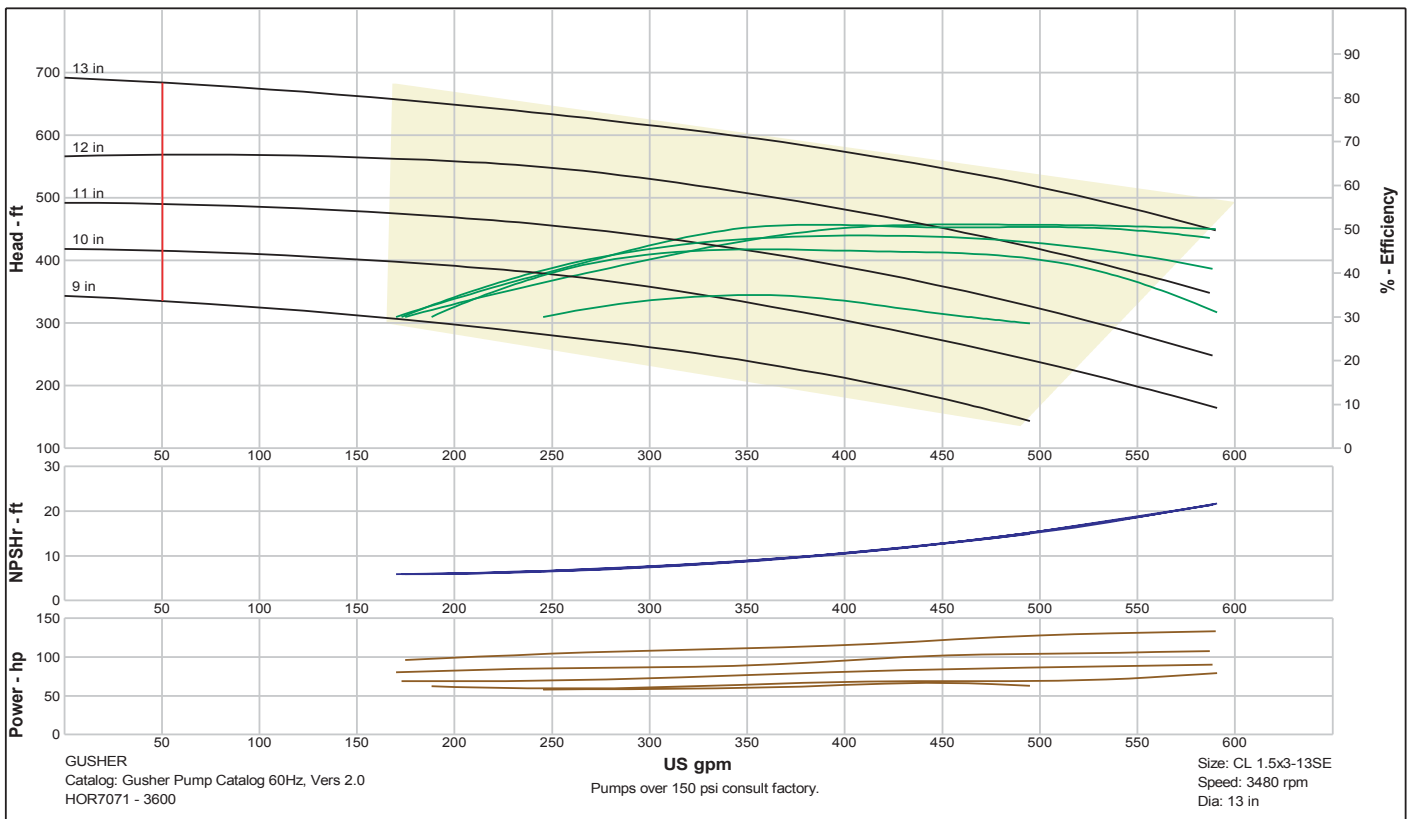

Pump Selection Curves

7071M CL 2x3-13SE 3480 rpm

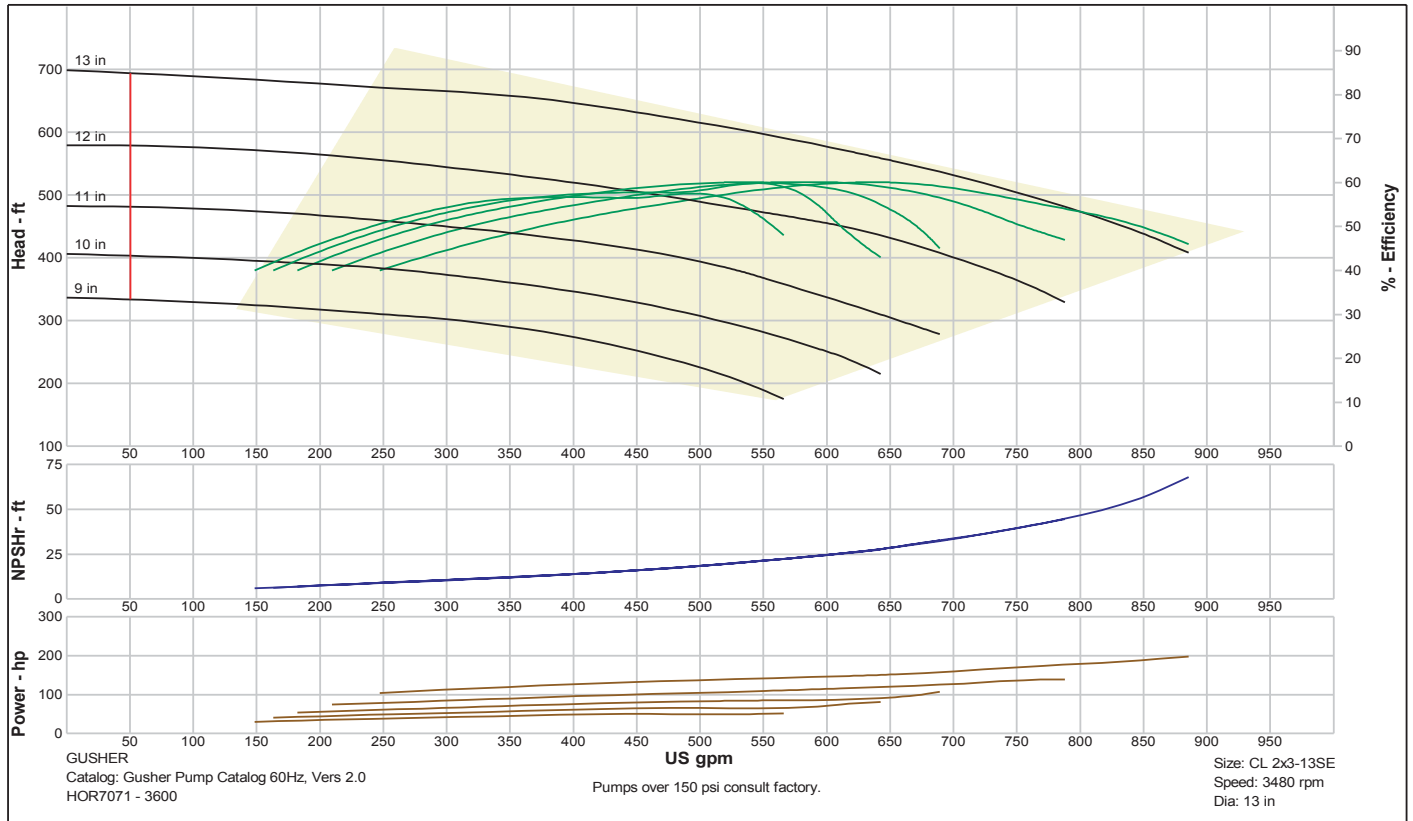

7071M CL 3x4-13SE 1765 rpm

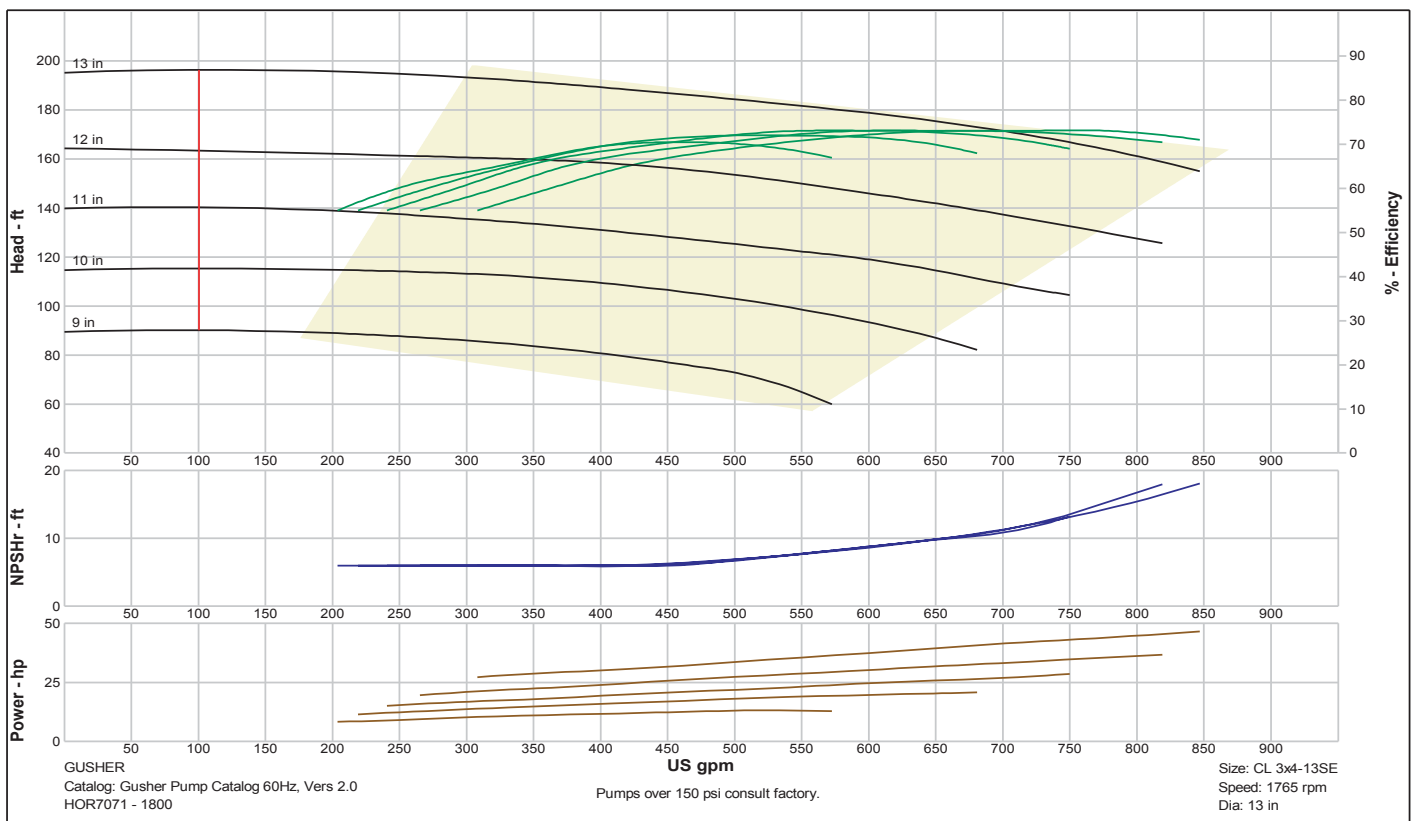

Pump Selection Curves

7071M CL 3x4-13SE 3480 rpm (10in. Impeller max.)

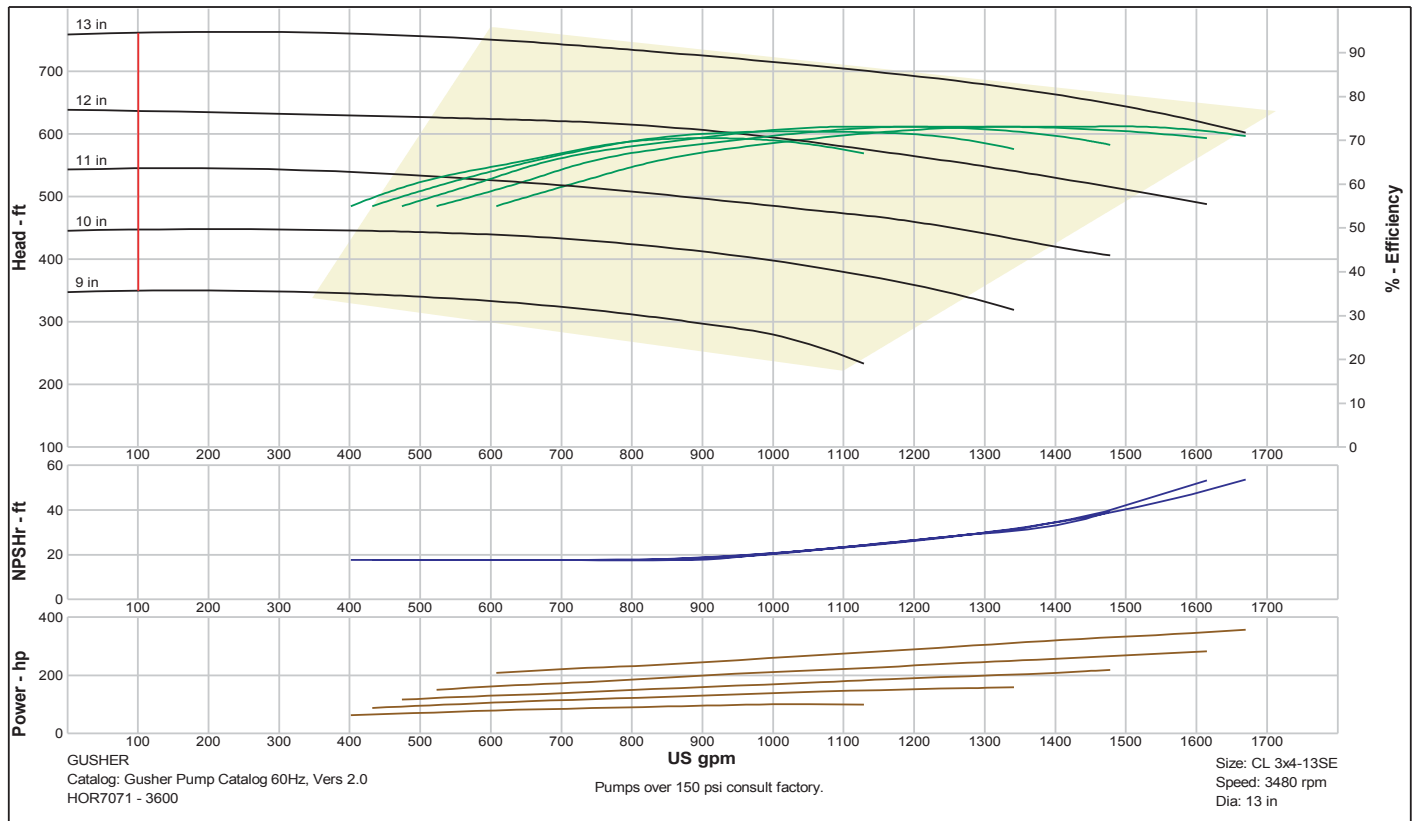

7071M CL 4x6-13SE 1765 rpm

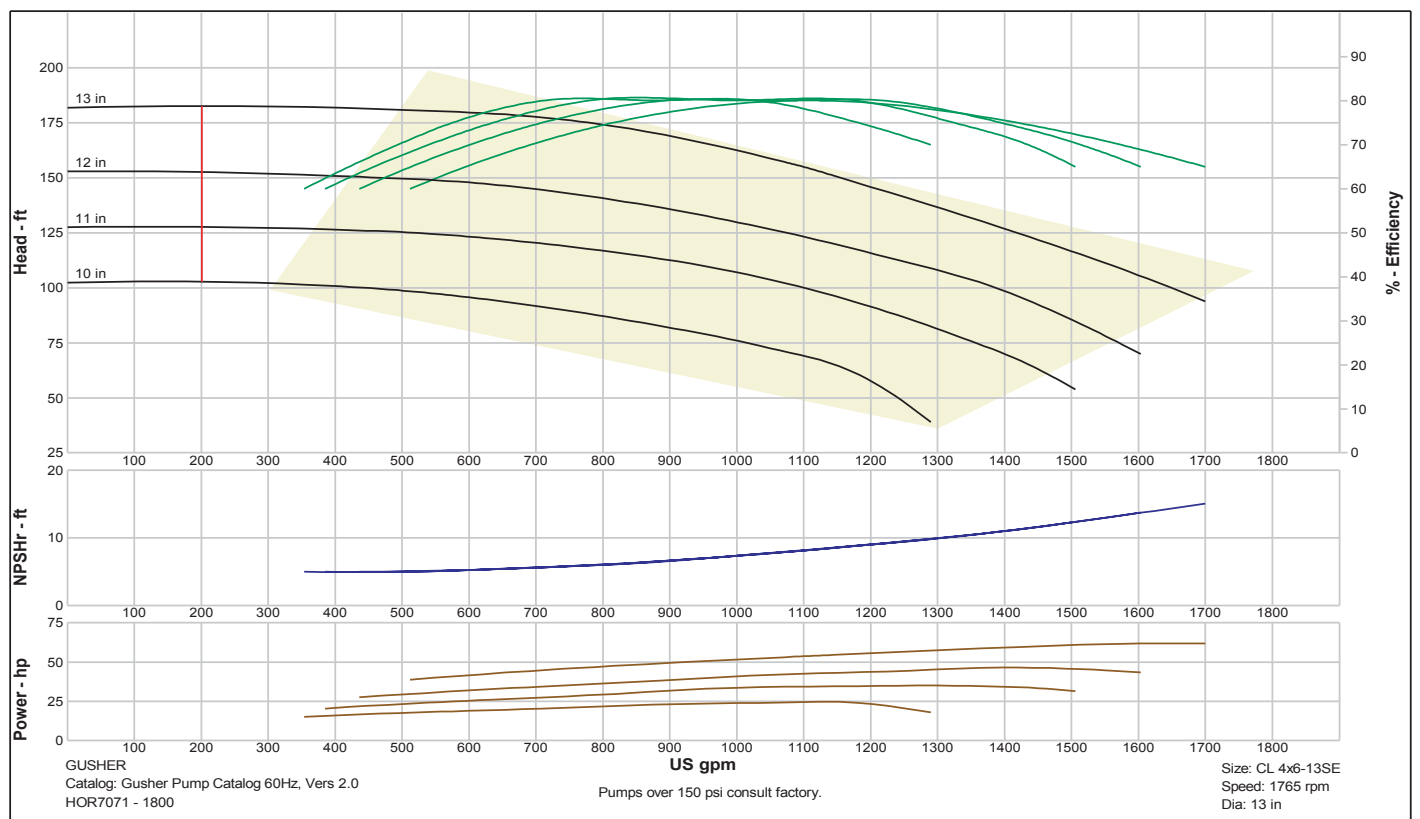

Pump Selection Curves

7071L CL 6x8-13SE 1765 rpm

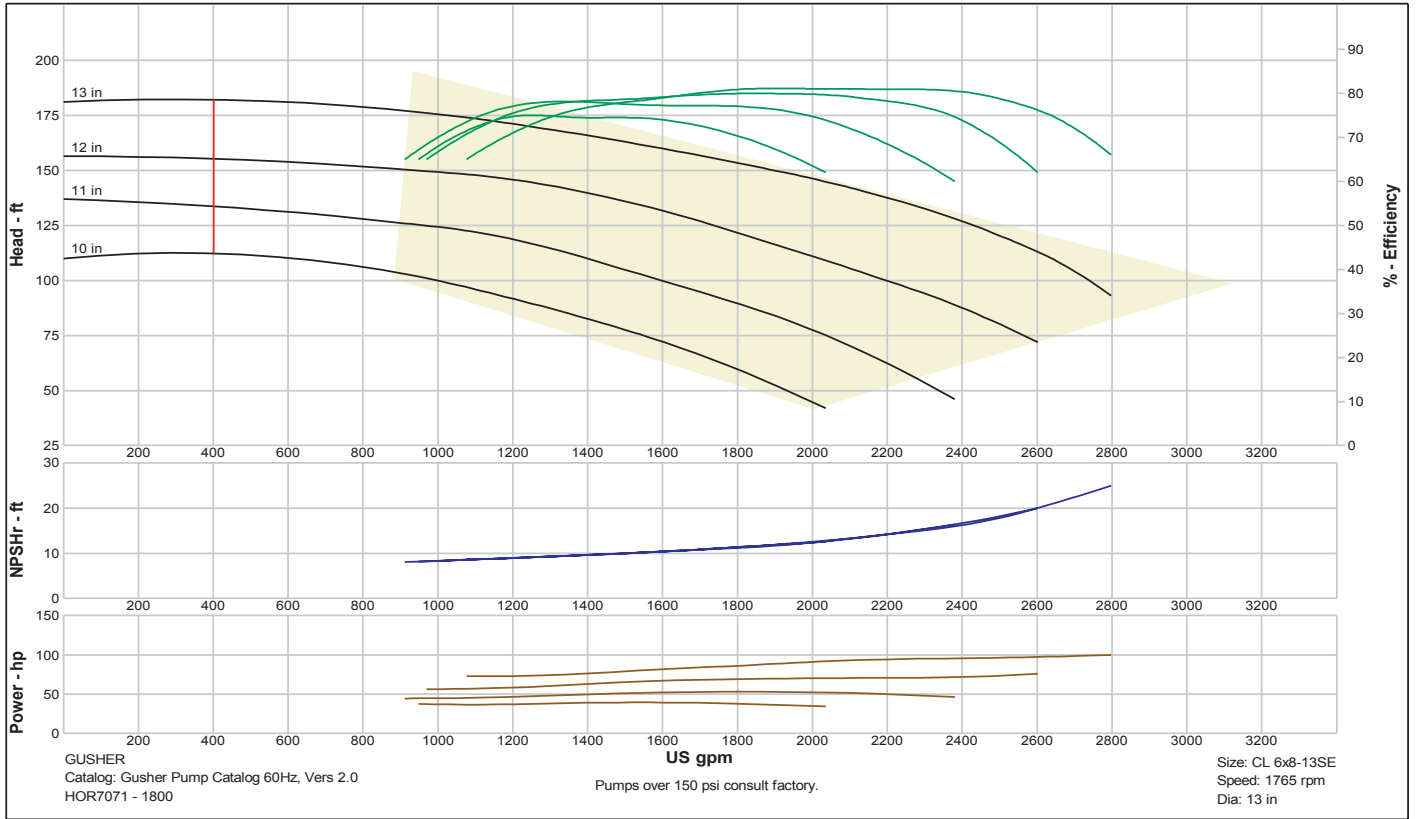

7071L CL 8x10-13SE 1765 rpm

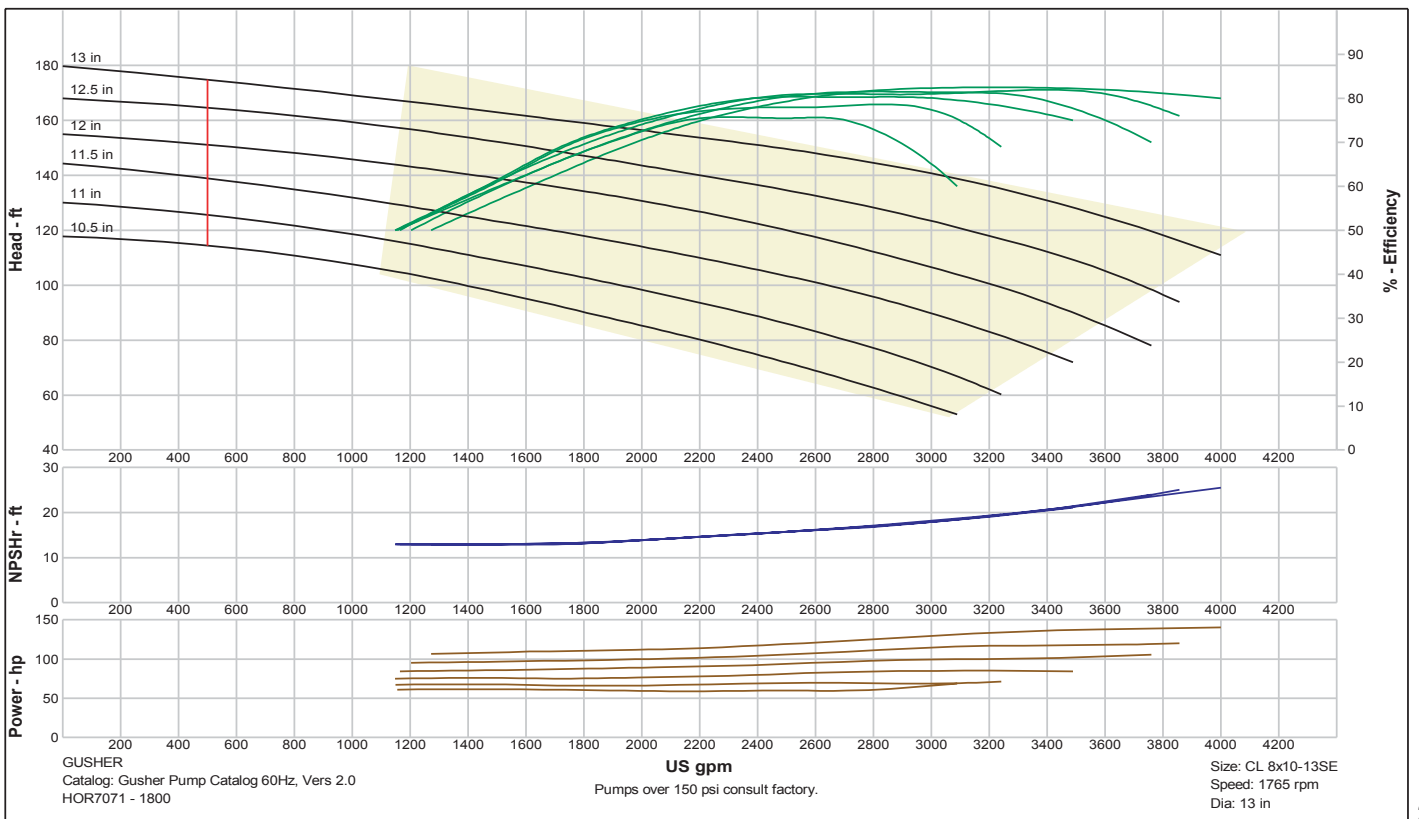

Pump Selection Curves

7071L CL 6x8-15SE 1765 rpm

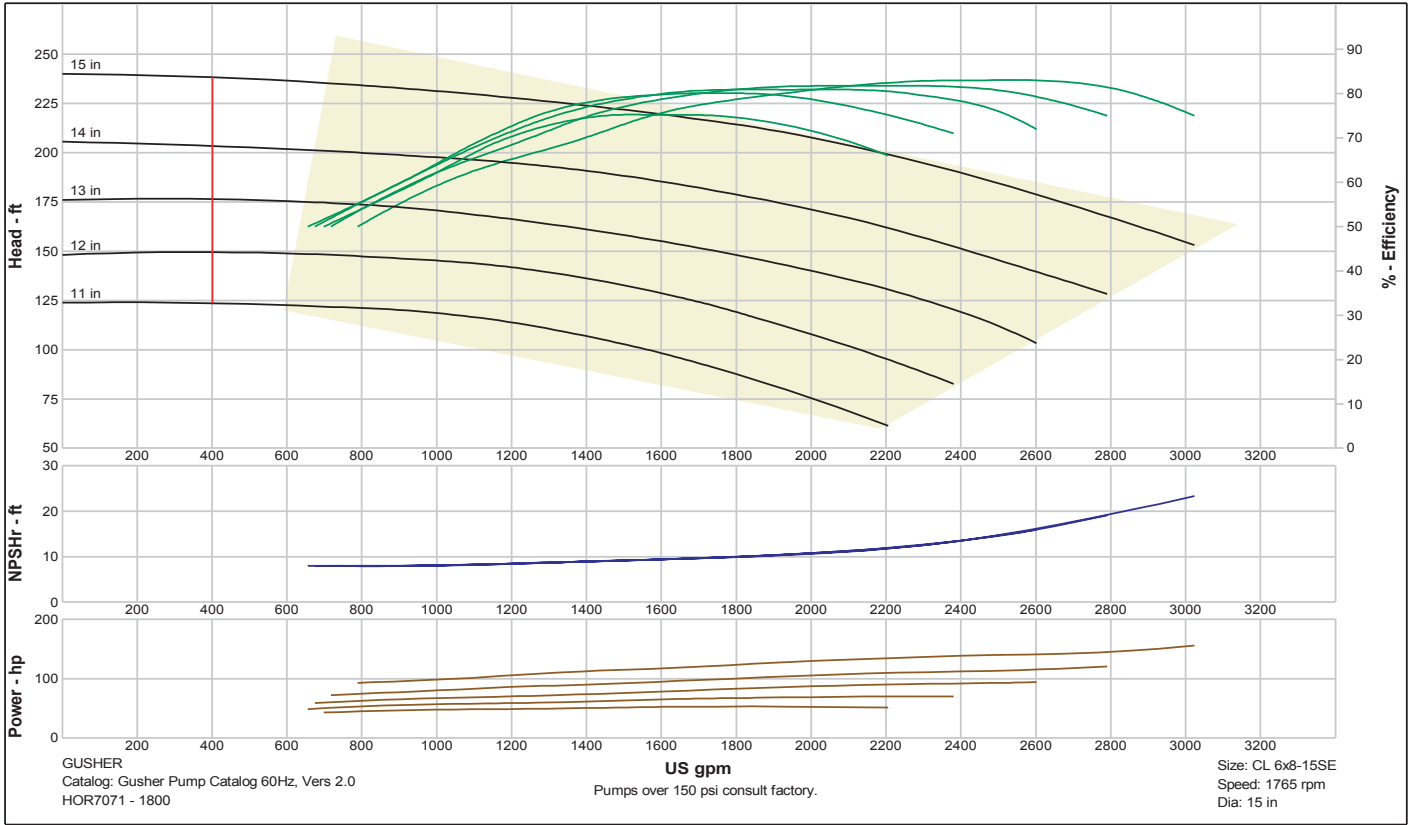

7071L CL 8x10-15SE 1170 rpm

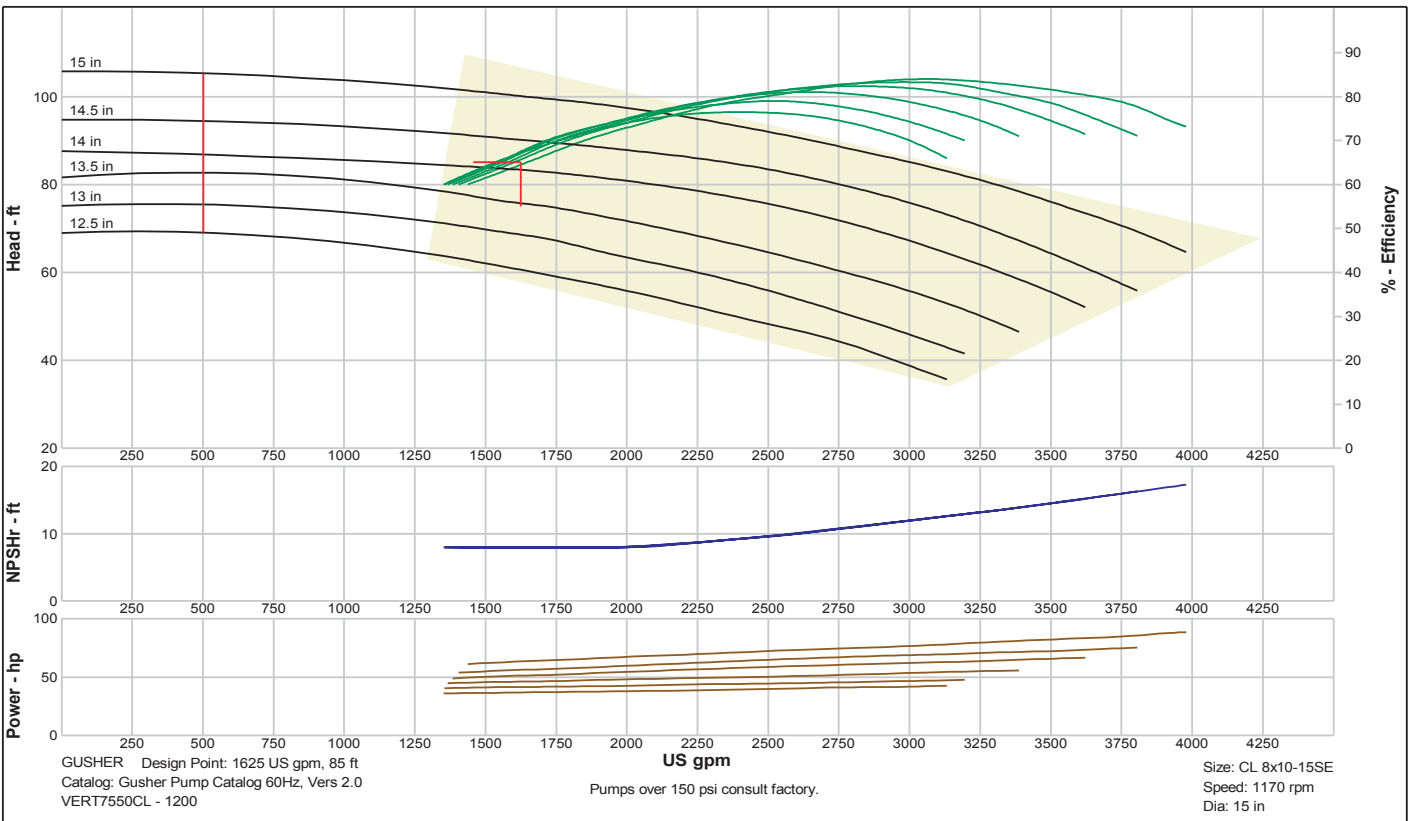

Pump Selection Curves

7071L CL 8x10-15BSE 1765 rpm

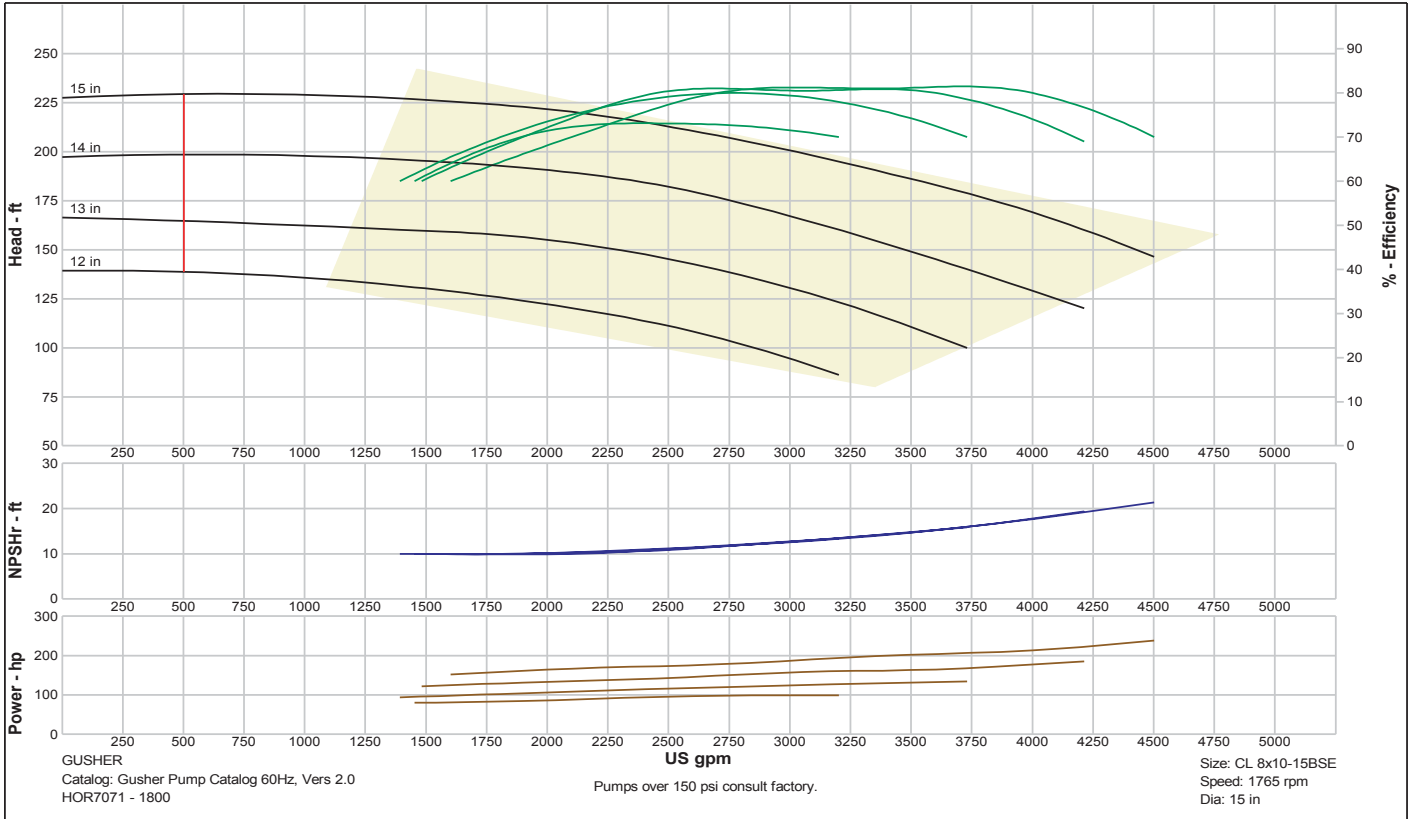

7071L CL 3x4-16SE 1765 rpm

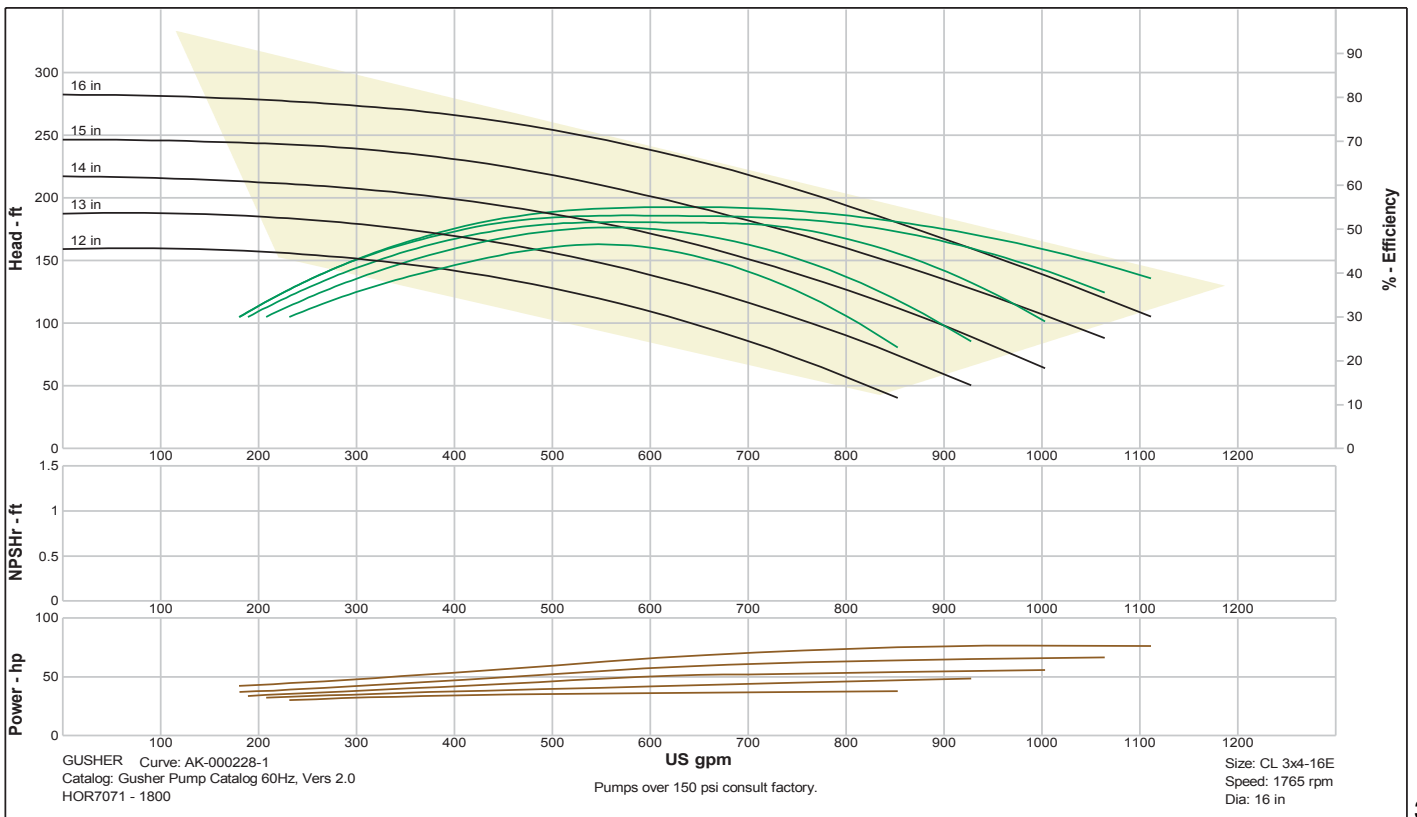

Pump Selection Curves

7071L CL 5x6-16SE 1765 rpm

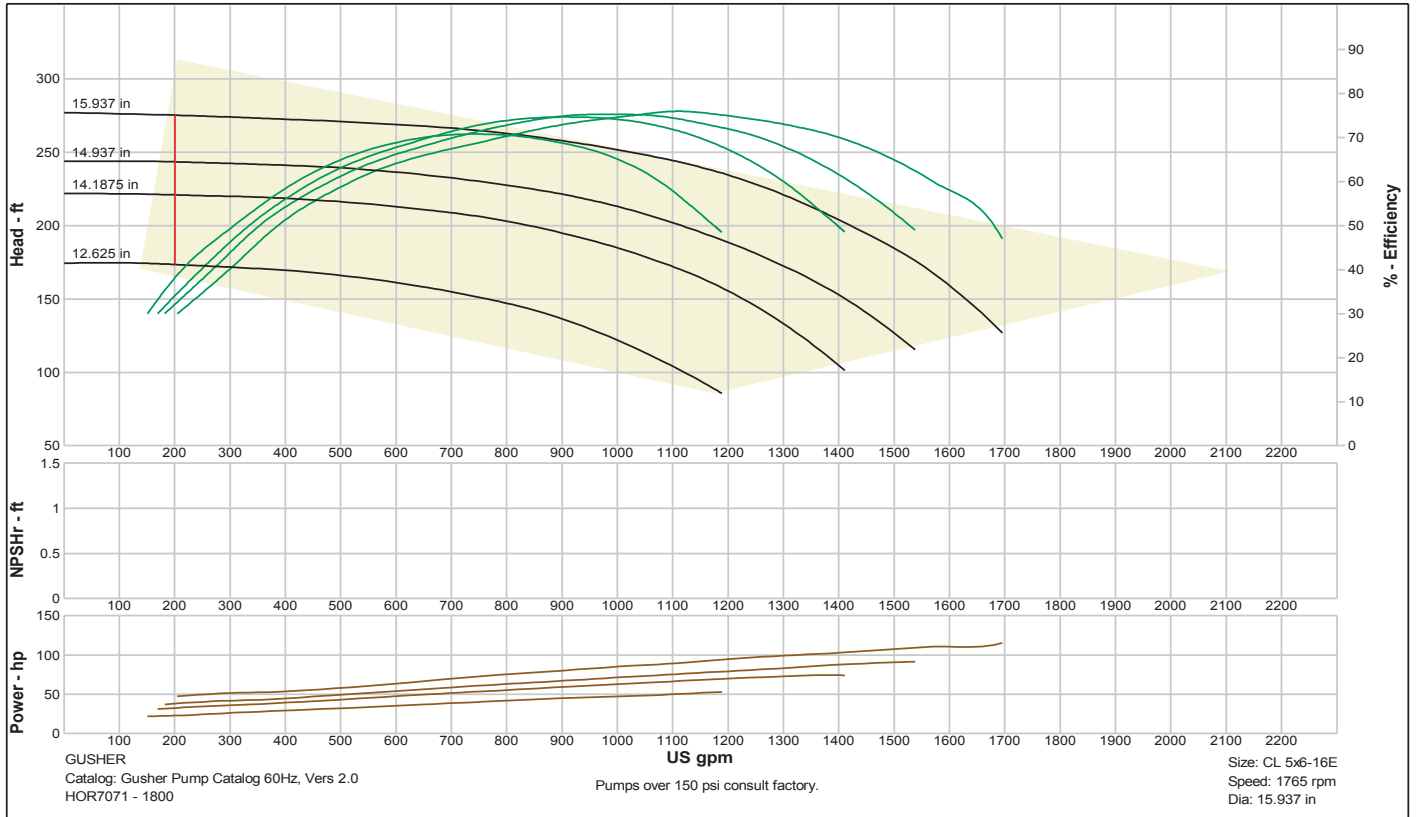

7071L CL 4x6-17E 1780 rpm

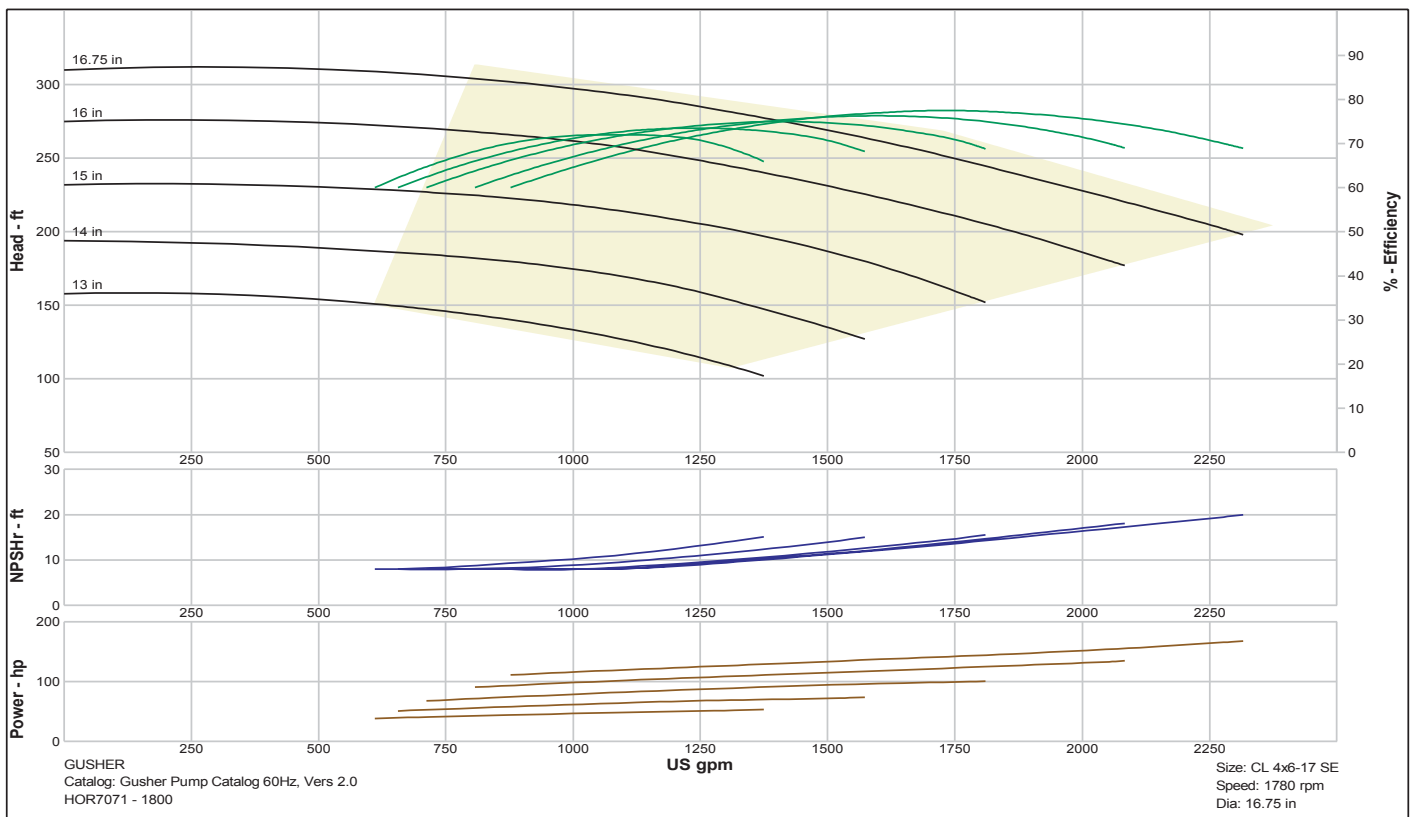

Pump Selection Curves

7071L CL 6x8-17E 1780 rpm

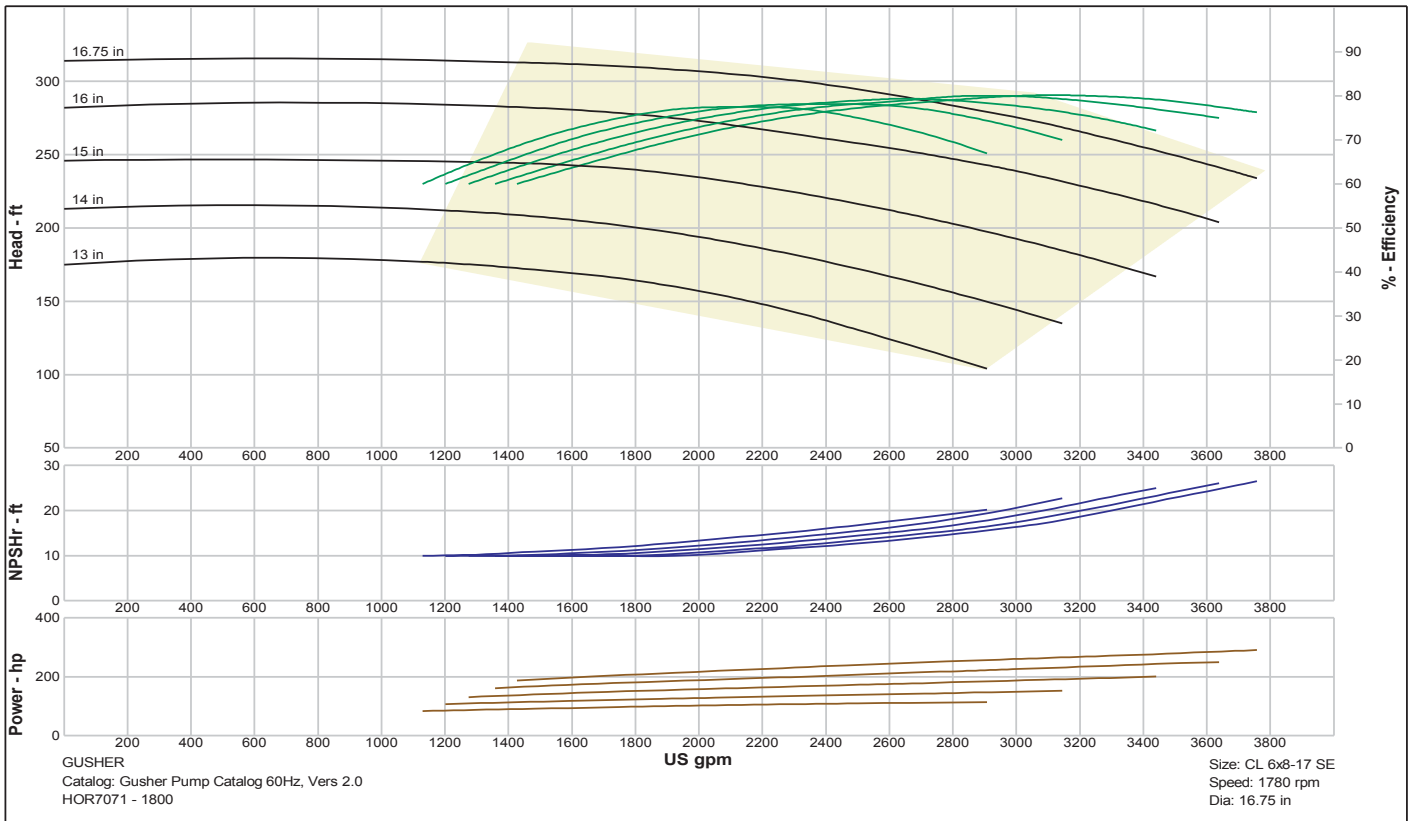

7071L CL 8x10-17SE 1765 rpm

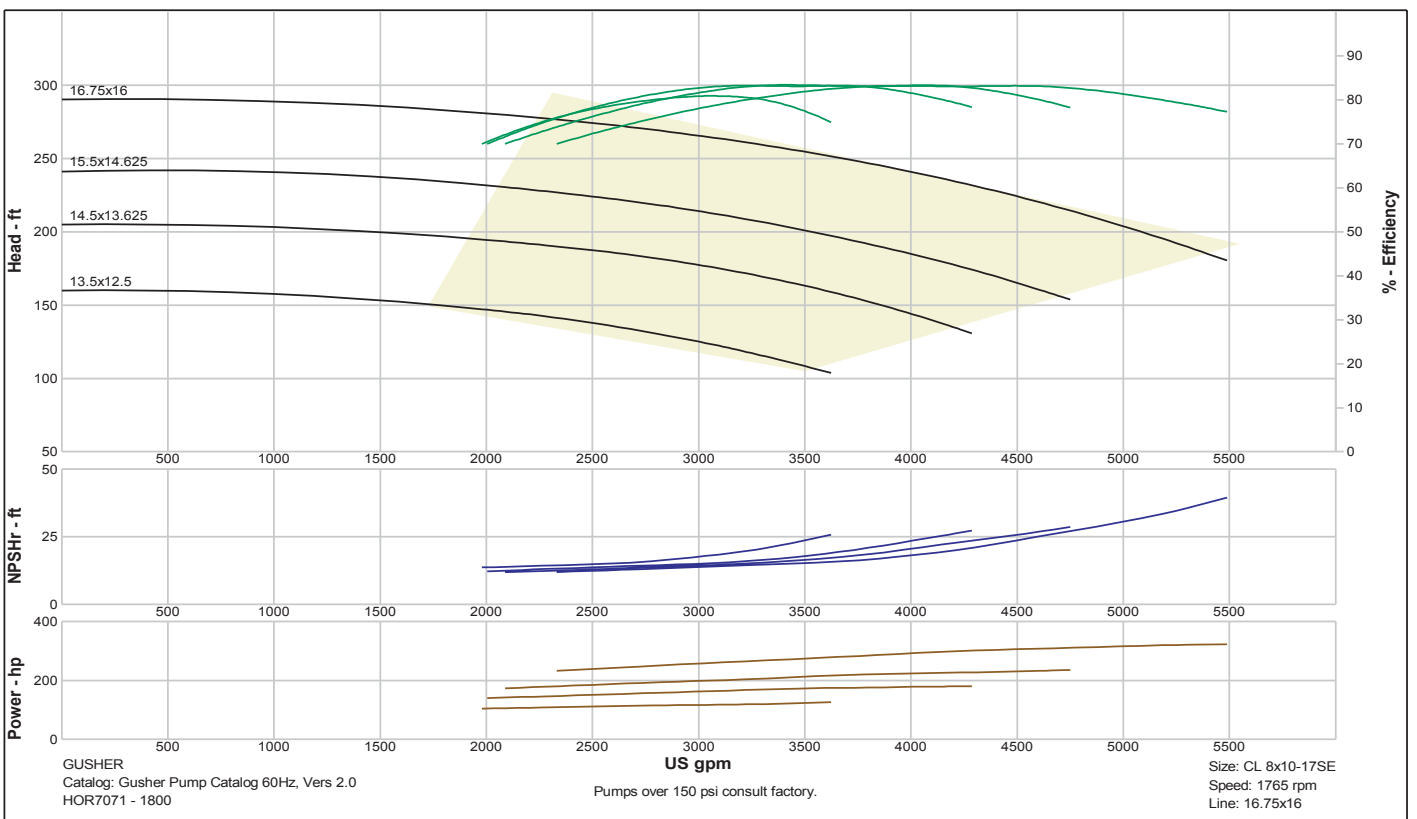

Ordering Information

Order the Gusher 7071 Series Pump to meet your needs by model number. The model number should be specified as follows:

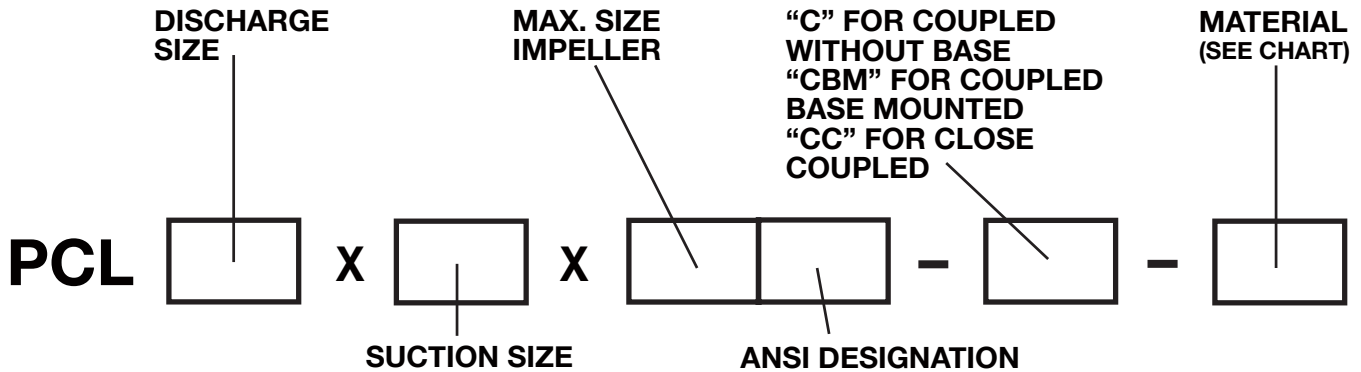

EXAMPLE: For ordering a coupled base-mounted pump with a 1" discharge and a 1 1/2" diameter suction, with impeller of 6" maximum, and ductile iron construction, the model number would be:

PCL-1 x 1 1/2-6AA-CBM-A

Standard Materials of Construction

Material Designation	Type	Description
A	All Ductile	Ductile Iron Construction
B	Stainless Steel	316 Stainless Steel Wetted Parts
C	Stainless Steel Fitted	316 Stainless Steel Shaft and Impeller

Other Materials are Available

Material Designation	Type
CD4	All CD4M construction
A20	All Alloy 20 construction
M	All Monel construction
H	Hast B or C construction, specify

Motor Specifications

Please furnish the following information on all orders: Horsepower, Frame Size, Voltage, RPM, Hertz and Phase. If a special motor is required, specify.

The **Base-Mounted Pump** is designed to accept a NEMA Frame Foot-Mounted Motor.

Note: If motor is ordered, it will be factory mounted unless otherwise specified.

We Can Help

Our engineering department will help you select the proper pump for your application. Call, write or email. Performance Curves are available on all pumps.

Call about our Quick Ship Program.

Gusher Pumps

115 Industrial Drive
Williamstown, KY 41097

Phone: 859.824.3100

Fax: 859.824.7248

Web: www.Gusher.com



A RUTHMAN COMPANY

www.Gusher.com

Ruthman Companies: A family-owned business supplying pumps for over 100 years



Ruthman Companies was co-founded in 1912 by brothers Alois and Edward Ruthman as the "Ruthman Machinery Company." Based in Cincinnati, the company serviced the steamboats that traveled the Ohio River.

In 1924, Alois conceived the first sealless centrifugal pump, coining the term 'coolant pump.' The brothers named this new pump "Gusher," giving birth to what is now Ruthman Companies' flagship brand, Gusher Pumps.

Alois' son Thomas R. Ruthman joined the family business in 1949, growing the business globally through organic growth and the acquisition of complementary technologies. In the early 1990's, Alois' grandson, Thomas G. Ruthman, became the third generation of Ruthmans in the pump business. Over the years, Ruthman Companies has expanded its product line from the original centrifugal coolant pumps to include valves, vertical turbine pumps, positive displacement pumps, gear pumps, and other specialized pump equipment, while upholding its reputation as a leader in the custom engineering of pumps for the most challenging applications.

GUSHER PUMPS LOCATIONS

Williamstown Headquarters

115 Industrial Road
Williamstown, KY 41097

Phone: 859.824.5001

Fax: 859.824.3011

Email: Info@Gusher.com

Dry Ridge Manufacturing

22 Ruthman Drive
Dry Ridge, KY 41035

Phone: 859.824.5001

Fax: 859.824.3011

Email: Info@Gusher.com

Dry Ridge Training Facility

3565 Dixie Highway
Dry Ridge, KY 41035

Phone: 859.824.5001

Email: Info@Gusher.com

New Castle Sales & Service

403 North Ninth Street
New Castle, IN 47362

Phone: 765.529.5624

Fax: 765.521.0008

Email: GusherNC@Gusher.com

Gusher Pumps, Shanghai

655 Caosheng Rd, Jiading District
Shanghai, China 201808

Phone: +86 (021) 55151993

Email: Flomo@Gusher.com

RUTHMAN COMPANIES MANUFACTURING DIVISIONS

BSM Pump Corp.

180 Frenchtown Road
North Kingstown, RI 02852

Phone: 401.471.6350

Fax: 401.471.6370

Email: Sales@BSMPump.com

www.BSMPump.com

Fulflo Hydraulic Valves

459 East Fancy Street
Blanchester, OH 45107

Phone: 937.783.2411

Fax: 937.783.4983

Email: Info@Fulflo.com

www.Fulflo.com

Nagle Pumps

1249 Center Avenue
Chicago Heights, IL 60411

Phone: 708.754.2940

Fax: 708.754.2944

www.NaglePumps.com

Process Systems Inc., Headquarters

23633 Pinewood Street
Warren, MI 48091

Phone: 586.757.5711

Fax: 586.758.6996

Email: Sales@PSI4Pumps.com

www.PSI4Pumps.com

Process Systems Inc., Midwest Service

485 N. State Route 341 South
Mellott, IN 47958

Phone: 765.295.2206

Fax: 765.295.2343

Email: Sales@PSI4Pumps.com

www.PSI4Pumps.com

RAE Pumps

1212 Streng Street
Cincinnati, OH 45223

Phone: 513.779.3034

www.RuthmanCompanies.com

Ruthman Pumps & Service

1212 Streng Street
Cincinnati, OH 45223

Phone: 513.559.3546

www.RuthmanCompanies.com

RUTHMAN COMPANIES GLOBAL DIVISIONS

Ruthmann Pumpen, LLC

Thomas-Edison-Str. 11
D-52499 Baesweiler
Germany

Phone: +49 (0) 2401 80489-0

Fax: + 49 (0) 2401 80489-20

Email: Info@RuthmannPumpen.de

www.RuthmannPumpen.de

RUTHMAN COMPANIES HEADQUARTERS

7236 Tylers Corner Drive
West Chester, OH 45069

Phone: 513.559.1901

www.RuthmanCompanies.com



RUTHMAN
Engineering Pump Solutions™

RC19-002/03-20