

LSA Pump Series – Low Maintenance, Abrasion Resistant

LSA-S, LSA-Expanded Range, LHD, MHD



Rock Solid Slurry Solutions

Primarily for heavy duty service in a variety of slurry applications, LSA pumps are widely used in ore transport, mill discharge, cyclone feed, tailings and plant process. The LSA can also be used for environmental cleanup, dewatering, pulp and paper, food process, coke and resin pumping and ash handling.

GIW's rugged design features, combined with shell, impeller and liner in proprietary GIW Gasite® material, are recognized worldwide for superior abrasion resistance. In addition, several impeller options to fine tune pump performance, and customized pumping needs are available. These options allow optimum wear life and sustained efficiency.

For maximum high power capability, each LSA pump is equipped with a heavy duty split cartridge bearing assembly with spherical roller radial bearings and a separate steep angle, self-aligning thrust bearing. The fused carbide coated shaft sleeve provides a smooth and extremely hard surface for long shaft seal life.

For ease of maintenance and maximum reliability, select an LSA pump and receive the lowest total cost of ownership.

**ROCK
SOLID
SOLUTIONS™**

GIW LSA Pump Features: Low Maintenance, Severe Duty, Abrasion Resistant

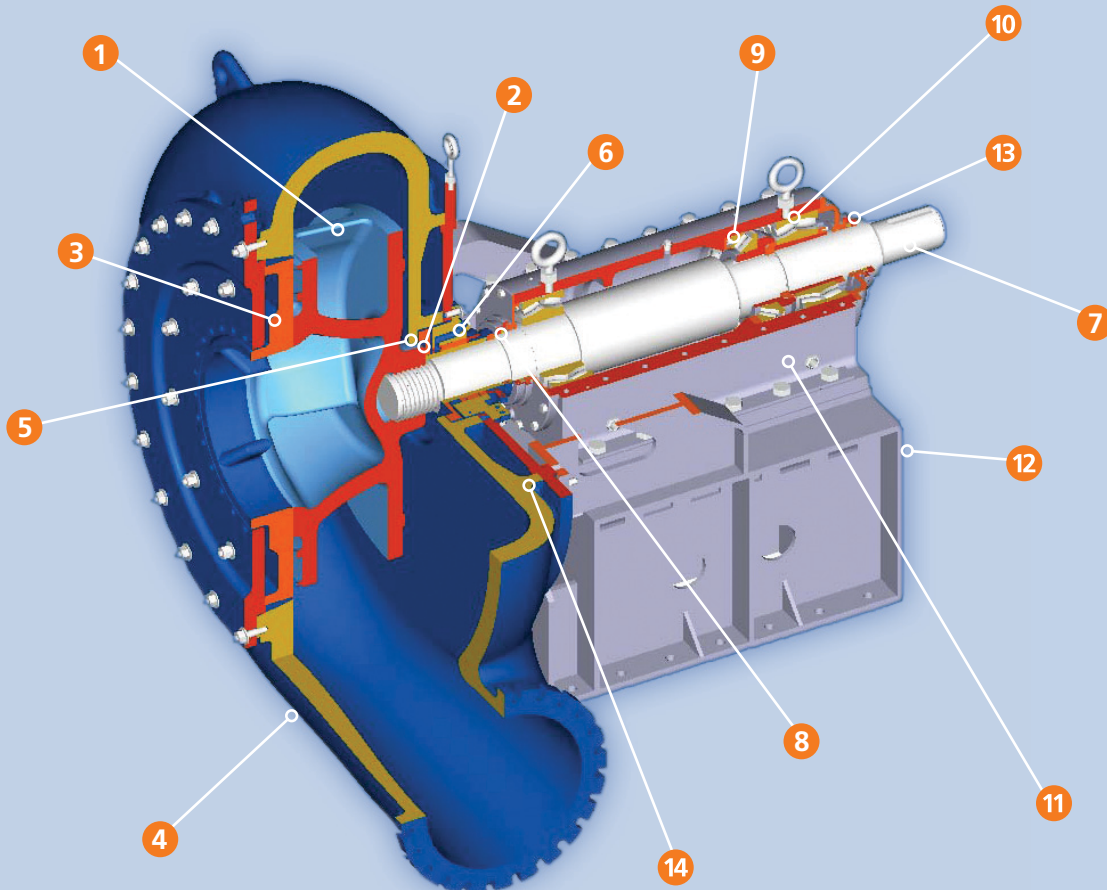

Applications

- Mineral processing (oil sands, copper, gold, iron ore, nickel, phosphate, coal)
- Power Generation
- Aggregate (sand & gravel)
- Ash Handling
- Flue Gas Desulfurization
- Thickener & Tailings
- Mine Dewatering
- Industrial Slurries
- Dredge



Rock Solid Components

- Gasite® (hi-chrome white iron) Wear Parts
- Heavy Duty Bearings
- Split Stuffing Box (ease of maintenance)
- Fused Carbide Coated Wear Resistant Shaft Sleeve

Rock Solid Construction

Horizontal end suction construction. Single wall pump shell with replaceable suction side liner; four vane impeller or three vane option for larger size solids.

Wear Parts

1. Impeller is designed for wear-resistant operation in highly abrasive slurries using GIW's flow simulation computer program.
2. Two aramid gaskets aid in the removal of the impeller.
3. Replaceable suction liner facilitates pump internal inspection and minimizes wear part usage and cost. Liner can be rotated at intervals to increase wear life.
4. Pump shell is computer designed to optimize wear and efficiency.

Shaft Seal

5. Replaceable wear plate maximizes stuffing box life. Reduced water consumption options available.
6. Shaft sleeve with fused carbide wear resistant coating to maximize packing life.

Mechanical End

7. Robust stiffened shaft to improve the wear life of the mechanical end and stuffing box.
8. Impeller release ring for safe and easy impeller removal. Feature is standard on larger pump sizes.
9. Spring retainer ring locates the thrust bearing preload springs for correct axial thrust load.
10. Radial bearings are a heavy duty, self-aligning, double-row, spherical roller-type design.
11. Split-cartridge bearing assembly offers ease of inspection and maintenance.
12. Accurate impeller clearance adjustments are easily made with the adjusting screw.
13. Labyrinth seals protect bearings.

Quick Alignment

14. Rabbet fits machined in the pedestal support the shell and provide component alignment.

Interchangeability

To optimize wear life and efficiency, various hydraulic design and material options can be used on the same mechanical end.

LSA Pump Series Options

GIW offers a large range of selections to meet your application needs. The LSA pump series is divided into four pump groups. This allows customers to select the type, size and operation speed that will perform the best. Pumps included in the LSA series are:

LSA S

normal severe duty requirements

LSA Expanded Range

duty-specific applications such as high pressure, coarse and fine slurry

LHD

low head, high flow applications

MHD

medium head, high flow applications

LSA Shaft Seals

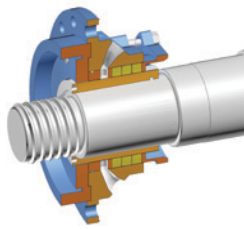

Throat Bushing

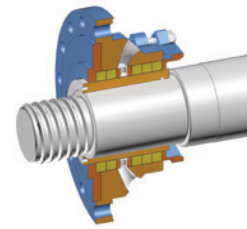

Minimum Dilution

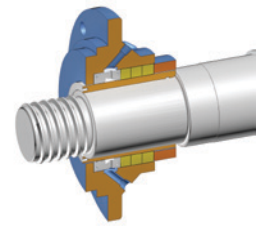

Spiral Trac™

Low Flow Stuffing Box Options

- Match customer needs
- Reduce flow up to 95%
- Maximize water control
- Restrict seal water flow into pump
- Pressure or flow controlled
- Minimize flush water spray
- Improve reliability

LSA S Pump Range*

Standard Pressure and Optimized Hydraulics

2000 to 7500 SFPM, 10 to 38 SMPS, 40% (or min. flow) to 120% BEPQ

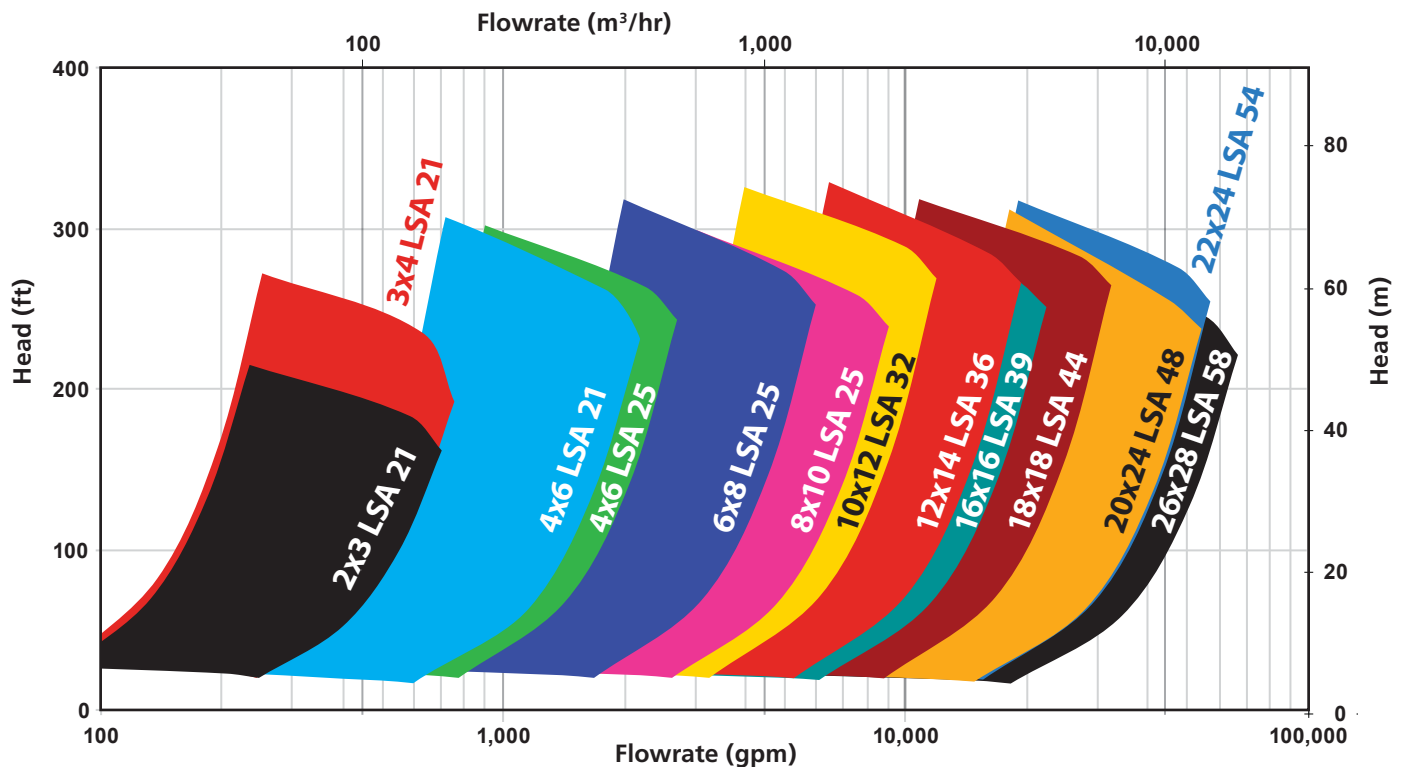

LSA S Range Pump Information Table

Assembly Number	Nominal Size		Maximum Operating Pressure		Free Passage		Discharge Position Intervals	Vane Number & Type
	in	mm	psi	bar	in	mm		
0572X	2x3-21	50x75-530	220	15.17	1.0x1.0	25x25	45	4ME
0573X	3x4-21	75x100-530	220	15.17	1.0x1.0	25x25	45	4ME
0574X	4X6-21	100x150-530	220	15.17	2.5X2.8	63X71	45	4ME
0516X	4X6-25	100x150-635	180	12.41	1.5x1.5	39x39	22.5	4ME
0501X	6x8-25	150x200-635	180	12.41	3.2x3.6	81x92	22.5	4ME
0575X	8x10-25	200x250-635	163	11.24	2.4x4.9	63x125	22.5	4ME
0562X	8x10-32	200x250-810	172	11.86	3.9x4.6	99x117	22.5	4ME
0563X	8X10-32	200x250-810	172	11.86	4.6x4.6	117x117	22.5	3ME
0564X, 0566X	8x10-32	200x250-810	172	11.86	3.9x4.6	99x117	15	4ME
0565X, 0567X	8x10-32	200x250-810	172	11.86	4.6x4.6	117x117	15	3ME
0576X, 0577X	10x12-32	250x300-810	140	9.65	3.7x6.7	95X171	15	4ME
0508X, 0510X	10x12-36	250x300-910	156	10.75	4.0x6.7	102x171	15	4ME
0509X, 0511X	10x12-36	250x300-910	156	10.75	6.3x6.7	160x171	15	3ME
0568X, 0570X	12x14-36	300x350-910	173	11.93	5.1x8.3	129x210	15	4ME
0569X, 0571X	12x14-36	300x350-910	173	11.93	6.4x8.3	162x210	15	3ME
0578X	16x16-39	400x400-990	120	8.27	5.8x8.2	148x209	15	4ME
0579X, 0580X	16x16-39	400x400-990	126	8.68	4.4x8.7	112x222	30	4ME
0581X, 0583X	16x18-44	400x450-1115	165	11.37	5.5x7.6	141x193	18	4ME
0582X, 0584X	16x18-44	400x450-1115	165	11.37	7.6X7.6	193x193	18	3ME
0538X, 0540X	18x18-44	450x450-1115	160	11.03	6.3x11.6	161x295	18	4ME
0539X, 0541X	18x18-44	450x450-1115	160	11.03	8.9x11.6	226x295	18	3ME
0589X, 0590X	20x20-48	500x600-1220	105	7.24	9.7x13.0	247x330	9	4ME
0548X	20x20-48	500x600-1220	130	8.96	9.7x13.0	247x330	15	4RV
0549X	20x24-48	500x600-1220	113	7.79	6.1x13.0	155x330	15	4ME
0550X	22x24-54	550x600-1370	186	12.82	8.1x13.5	208x343	18	4ME
0551X	26x28-58	650x700-1470	91	6.27	8.6x11.7	218x298	15	4ME

Discharge Positions

Rotation direction is clockwise from the drive end. A vertical discharge is standard.

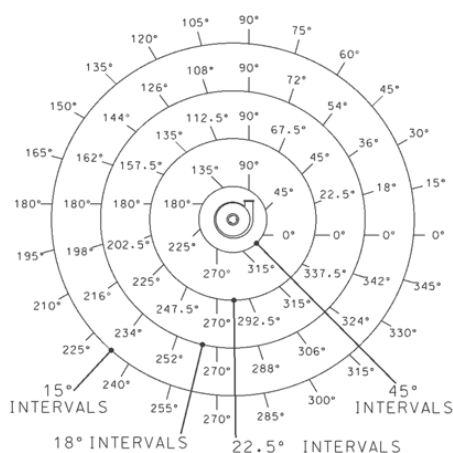

Capacities (Q max.) 100-60,000 gpm (20-13,600 m³/h)

Heads (H max.) 300 ft (90 m)

Normal temperature limit is 150° F (65°C). Consult the factory for materials and configurations for temperatures above 150° F.

Materials

Part No	Item	Standard
101	Shell	Gasite® WD28G
230	Impeller	Gasite® WD28G
16-1	Suction Plate	Ductile Iron
13-19	Suction Liner	Gasite® 18G
332	Pedestal	Fab Steel
210	Shaft	4150 Steel
451	Stuffing Box	Grey Iron
524	Shaft Sleeve	Carbide Coated Steel
350	Bearing Housing	Grey Iron

Alternate material options are available.

LSA Expanded Pump Range*

High Pressure and Other Available Hydraulics

2000 to 7500 SFPM, 10 to 38 SMPS, 40% (or min. flow) to 120% BEPQ

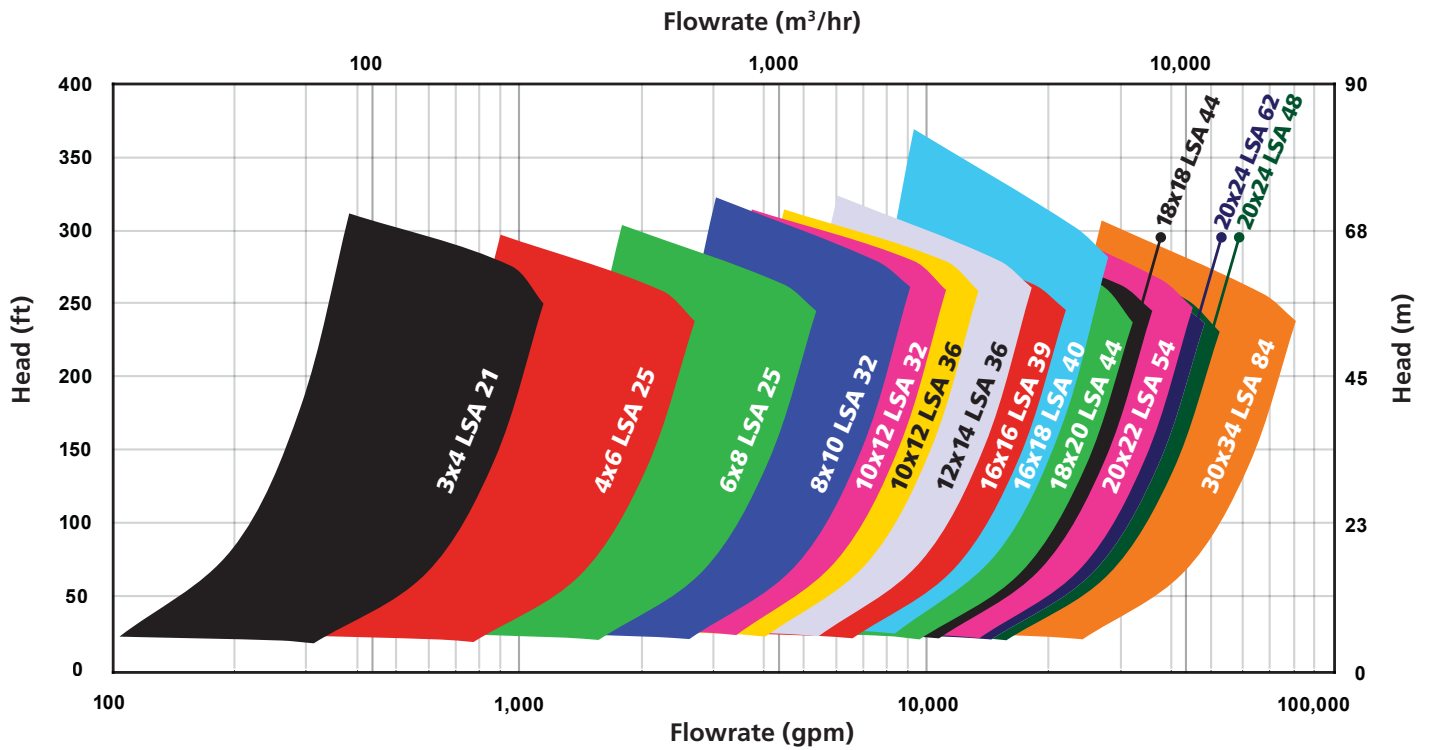

LHD Pump Range*

High Specific Speed Pumps –
6500 SFPM, 33.0 SMPS,
Approx. 50% to 110% BEPQ

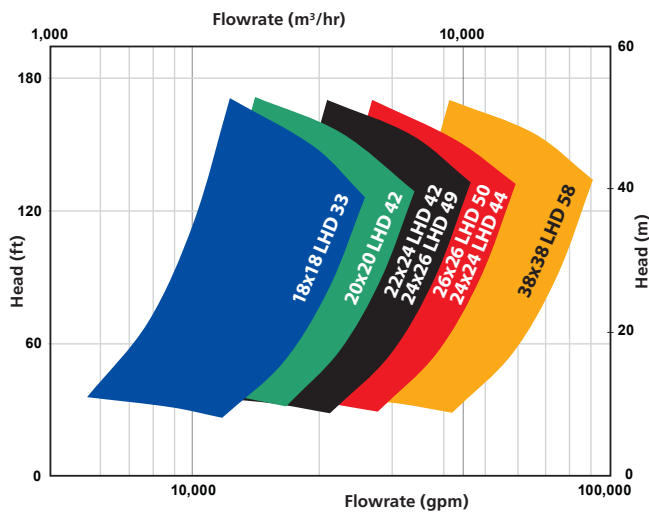

MHD Pump Range*

Low and Medium Specific Speed Pumps –
6800 SFPM, 34.5 SMPS,
Approx. 50% to 110% BEPQ

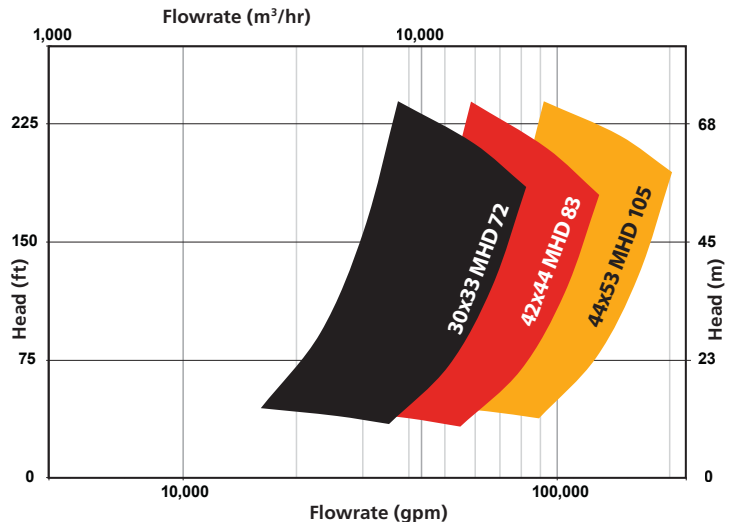

* Charts do not include all available options.

LSA Expanded Range Pump Information Table

Assembly Number	Nominal Size		Maximum Operating Pressure		Free Passage		Discharge Position Intervals	Vane Number & Type
	in	mm	psi	bar	in	mm	degrees	
9603D	3X4-21	75X100-530	500	34.44	1x2.3	25x58	45	4ME
9606D	4X6-25	100X150-635	999	68.88	1.56x3.3	40x84	22.5	4ME
9602D	6X8-25	150X200-635	1074	74.05	3.2x3.6	81x91	22.5	4ME
9594D	8X10-32	200X250-810	728	50.16	3.9x4.6	99x117	15	4ME
9575D	10X12-32	250X300-810	600	41.37	4.2x6.5	107x165	15	4ME
9555D	10X12-36	250X300-910	600	41.37	4x6.75	102x171	15	4ME
9818D	12X14-36	300X350-910	575	39.61	5.1x8.3	130x211	15	4ME
9514D	14X16-40	350X400-1015	630	43.44	6x6.2	152x157	9	4ME
9572D	16X16-39	400X400-990	500	34.44	5.7x8	145x203	15	4ME
9635D	16X18-40	400X450-1015	345	23.79	4.9x7.9	124x201	18	5ME
9554D	18X18-44	450X450-1115	303	20.89	6.3x10	160x254	9	4ME
9579D	18X18-50	450X450-1270	285	19.65	5.5x8.1	140x206	9	5ME
9544D	18X20-44	450X500-1115	303	20.89	6.3x10	160x254	9	5HE
9573D	20X22-54	500X550-1370	184	12.66	8x10.25	203x260	15	4ME
9827D	20X24-48	500X600-1220	175	12.04	5x12	127x305	15	5ME
9834D	20X24-62	500X600-1575	320	22.03	11.5x11.7	292x297	12.86	3ME
9835D	20X25-62	500X635-1575	300	20.68	10.2x10.4	259x264	15	3ME
9837D	24X24-62	600X600-1575	425	29.27	11.5x11.7	292x297	12.86	3ME
9527D	30X34-84	760X860-2130	300	20.68	13.5x14.7	343x373	11.25	3ME

LHD Range Pump Information Table

Assembly Number	Nominal Size		Maximum Operating Pressure		Free Passage		Discharge Position Intervals	Vane Number & Type
	in	mm	psi	bar	in	mm	degrees	
9601D	18X18-33	450X450-830	117	8	6.6X8.0	168X203	15	3ME
9518D	20X20-42	500X500-1065	133	9.2	9.6X10.6	245X269	9	3ME
9819D	22X24-42	550X600-1065	160	11	11.5X12.0	292X305	9	3ME
9607D	24X24-44	600X600-1115	97	6.7	11.0X16.0	279X406	9	3ME
9814D	24X26-49	600X650-1245	220	15.2	7.7X14.1	196X358	15	4ME
9455D	26X26-50	650X650-1270	147	10.1	15.0X15.3	381X387	22.5	3ME
9300D	38X38-58	950X950-1473	87	6	12.4X13.7	315X348	N/A	4HE

MHD Range Pump Information Table

Assembly Number	Nominal Size		Maximum Operating Pressure		Free Passage		Discharge Position Intervals	Vane Number & Type
	in	mm	psi	bar	in	mm	degrees	
9689D	24X28-58	600X700-1473	137	9.4	9.3X13.8	236X349	15	4ME
9526D	30X33-72	750X825-1825	191	13.2	15.5X15.8	394X401	11.25	3ME
5417D	42X44-83	1050X1100-2108	70	4.8	16.2X19.2	412X488	N/A	3ME
9068D	44X53-105	1100X1325-2667	N/A	N/A	21.3X23.0	541X584	N/A	4ME

Ancillary Products

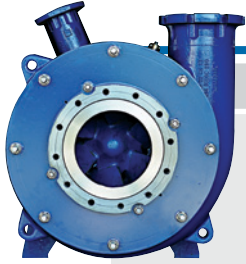

Heavy Duty Pumps

HVF (High Volume Froth) Pump

GIW's HVF pump provides continuous operation without shutdown or operator intervention. The new hydraulic design removes air from the impeller eye while the pump is running and the pump can be retrofit into any existing application. It is environmentally-friendly and cost effective.

- Eliminate sump overflow due to pump airlock
- Reduce downtime
- Allow water use to be restricted to the bare minimum



ZW Double-Suction Vertical Pump

GIW's ZW Pump is a vertical cantilever, rugged hard metal sump pump with top and bottom suction and no submerged bearings. It yields an economical answer for abrasive slurries, dewatering, floor clean up and process transfer. Heavy-duty bearing arrangement delivers increased service life.

- High chrome material configuration
- Maximum wear resistance
- Wide variety of motor size options

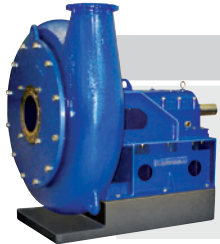

MDX Mill Duty Xtra Heavy Pump

The latest technology from GIW provides superior wear life and increased up time handling your most aggressive slurry applications. Ideal for SAG and Ball Mill circuits, mill discharge, cyclone and screen feed.

- Features slurry diverter for long wear life
- Adjustable suction liner
- Lower specific speed design

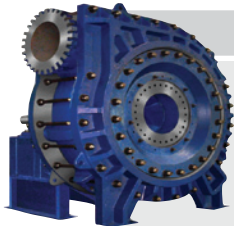

TBC High Pressure Pump

The TBC design can achieve very high pressures because the pressure load against the liners is transferred to the non-wearing side plates, which are held together by large tie bolts. Impeller hydraulics are computer designed for high suction performance and large solids passage.

- High heads and flows for hydraulic transport
- Maintenance friendly impeller release ring
- Features slurry diverter for long wear life



WBC High Pressure Pump

Patented design incorporates state-of-the-art hydraulic and wear technologies for heavy duty, high pressure applications. The pump shell is designed to reduce bending moments and associated stresses that can cause a structural failure during a pressure surge.

- Maintenance friendly impeller release ring
- Superior suction performance
- 3 vane impeller design for large sphere passage

GIW Industries, Inc.
 5000 Wrightsboro Road
 Grovetown, Georgia 30813-2842, USA
 Telephone +1-706-863-1011
 Fax +1-706-863-5637
www.giwindustries.com



A KSB Company . 

**ROCK
 SOLID
 SOLUTIONS™**