



**50L, 65L, 95L, 120L,
160L, 250L, 320L**

6" Stainless Steel Submersible Pumps

60 HZ HIGH CAPACITY - FOR 6" AND LARGER WELLS

FEATURES

Powered for Continuous Operation: All ratings are within the working limits of the motor. Pump can be operated continuously.

New Design Features: Cast 304 SS discharge head and motor adapter.

Field Serviceable: Easy to install and service. All parts easily dismantled if field service is ever necessary.

Diverse Application: Designed for commercial, municipal and agricultural water needs.

Stainless Steel Construction: Durable in most waters.

Bearings: Replaceable, silicon carbide bearings allow excellent abrasives handling and wear resistance.

Built-in Check Valve: Positive sealing, stainless steel check valve assembly incorporated into discharge head.

Impellers: New stainless steel impeller design provides improved efficiency.

Maximum Temperature: 140°F (60°C) for pump.

Four-Fluted Shaft Design: Four sided stainless steel shaft eliminates impeller keys and provides positive drive.

Coupling: Removable heavy duty stainless steel, splined coupling for maximum load-carrying capability.

Suction Strainer: Stainless steel strainer restricts gravel and other debris from entering the pump.

Cable Guard: Stainless steel cable guard surrounds and protects motor leads.

Fasteners: All fasteners are stainless steel.

CentriPro Motors: Designed to NEMA standards. Stainless steel casing resists corrosion. Water filled design provides a constant supply of lubrication. Hermetically sealed stator assures moisture free windings. Durable Kingsbury type thrust bearing absorbs all thrust. Replaceable motor lead assembly.

Certified to NSF/ANSI 61, Annex G.

SPECIFICATIONS

Model	Horsepower Range	Discharge Connection	Recommended GPM Operating Range	GPM at Best Efficiency	Minimum* Well Size	Rotation at Discharge End
50L	3 - 20	3" NPT	17 - 70	50	6" / 8" *	CCW
65L	3 - 40		20 - 90	65		
95L	5 - 40		25 - 130	90		
120L	5 - 50		40 - 170	120		
160L	3 - 60		50 - 240	160	6"	
250L	7.5 - 60		70 - 300	250		
320L	7.5 - 60	4" NPT	100 - 400	320		

* Minimum well size refers only to dimensional fit in a well, the specifier or installer must determine the minimum required well diameter that will insure an adequate supply of water to the pump and also properly cool the motor. See Water End Data Chart for specific diameter by model number.

AGENCY LISTINGS



NSF/ANSI 372 - Drinking Water System Components - Lead Content

CLASS 6853 01 - Low Lead Content Certification Program - Plumbing Products



Pump/Water End - Drinking Water System Components - Certified to NSF/ANSI 61, Annex G

"L" SERIES MATERIALS OF CONSTRUCTION

Ref. No.	Part Name	Material	Material Code
1	Discharge Head	Stainless steel	ASTM CF-8 (AISI 304 cast)
2	Check Valve Support	Stainless steel	ASTM CF-8 (AISI 304 cast)
3	Check Valve	Stainless steel	AISI 304 SS
4	Elastomers	Ethylene propylene	EPDM
5	Bolts and Screws	Stainless steel	AISI 304 SS
6	Shaft Sleeve and Bushing	Tungsten carbide	-
7	Thrust Bearing	PTFE+Graphite	-
8	Impeller	Stainless steel	AISI 304 SS
9	Diffuser	Stainless steel	AISI 304 SS
10	Spacer	Stainless steel	AISI 431 SS
11	Tie Rod	Stainless steel	AISI 304 SS
12	Cable Guard	Stainless steel	AISI 304 SS
13	Wear Rings	Technopolymer PPO	Engineered polymer
14	Strainer	Stainless steel	AISI 304 SS
15	Shaft	Stainless steel	AISI 431 SS
16	Shaft Coupling	Stainless steel	AISI 431 SS
17	Motor Adapter	Stainless steel	ASTM CF-8 (AISI 304 cast)

SYSTEM COMPONENTS

■ Pump/Water End:

- 50L-250L with 3" NPT discharge.
- 320L with 4" NPT discharge.
- 3 HP Water Ends Have 4" Motor Adapters
- 5 & 7.5 HP Water Ends Have Either a 4" or 6" Motor Adapter (see Water End Data chart)
- 10 HP and Larger Water Ends Have 6" Motor Adapters

■ Motor:

- 4" motor required for 3 HP and 5 HP pumps.
- 4" or 6" motors can be used for 7.5 HP pumps.
- 6" motor required for 10 HP and larger pumps.

■ **Control Box:** Required for all single phase motors.

■ **Magnetic Starter:** A magnetic starter with Class 10 overloads is required for all three phase units.

WATER ENDS AND MOTORS MUST BE ORDERED SEPARATELY AND ARE PACKAGED SEPARATELY.

ORDER NUMBER CODE

	65	L	03	
				Horsepower Code =
	50			HP
	65			03 = 3
	95			05 = 5 (4" motor)
	120			05-6 = 5 (6" motor)
	160			07-4 = 7.5 (4" motor)
	250			07 = 7.5 (6" motor)
	320			10 = 10
Pump Size/ Gallons per minute at Best Efficiency Point				15 = 15
				20 = 20
Pump Series				25 = 25
				30 = 30
				40 = 40
				50 = 50
				60 = 60

WATER END (PUMP) DATA

Model	Order No.	No. Stages	Min. HP Required	Required Motor Dia.	Dimensions & Weights						
					Length		Diameter		Weight		
					in.	mm	in.	mm	lbs.	kg.	
50L	50L03	4	3	4	20.6	522	5.59	142	25	11	
	50L05R**	7	5	4/6	25.8	656	5.67	144	35	16	
	50L05**	8	5		27.8	706			40	18	
	50L07**	11	7.5		33.3	844			49	22	
	50L10	15	10	6	40.2	1020			57	26	
	50L15	23	15		56.9	1446			82	37	
50L20	28	20	65.8		1670	94			43		
65L	65L03	3	3	4	18.6	472	5.59	142	26	12	
	65L05**	5	5	4/6	22.2	564	5.67	144	31	14	
	65L07**	7	7.5		25.8	656			35	16	
	65L10	10	10		31.3	794			44	20	
	65L15	16	15	6	42.1	1070			60	27	
	65L20	21	20		53.0	1346			75	34	
	65L25	27	25		63.9	1622			90	41	
	65L30*	32	30		98.7	2508			220	100	
65L40*	41	40	115.0		2922	6.97*			177	253	115
95L	95L05**	3	5	4/6	18.6	472	5.59	142	26	12	
	95L07**	5	7.5	4/6	22.2	564	5.67	144	31	14	
	95L10	7	10		25.8	656			35	16	
	95L15	10	15		31.3	794			44	20	
	95L20	14	20	6	38.5	978			53	24	
	95L25	17	25		43.9	1116			62	28	
	95L30	21	30		53.0	1346			75	34	
	95L40*	28	40		67.3	1710			6.97*	177	156
120L	120L05**	2	5		4/6	16.8			426	5.59	142
	120L07**	3	7.5	4/6	19.5	495	5.67	144	26	12	
	120L10	5	10		24.9	633			33	15	
	120L15	7	15		30.4	771			40	18	
	120L20	10	20	6	38.5	978			51	23	
	120L25	12	25		43.9	1116			57	26	
	120L30	15	30		52.1	1323			68	31	
	120L40	20	40		65.7	1668			86	39	
120L50*	24	50	80.9		2055	6.97*			177	179	81
160L	160L03	1	3	4	14.5	367	5.59	142	18	8	
	160L05**	2	5	4/6	17.2	436	5.67	144	22	10	
	160L07**	3	7.5		19.9	505			26	12	
	160L10	4	10		22.6	574			31	14	
	160L15	6	15	6	28.0	712			37	17	
	160L20	8	20		33.5	850			44	20	
	160L25	9	25		36.2	919			46	21	
	160L30	11	30		41.6	1057			53	24	
	160L40	15	40		52.5	1333			68	31	
	160L50	18	50		60.6	1540			77	35	
160L60	20	60	65.7		1668	86			39		
250L	250L07**	2	7.5	4/6	20.8	528	5.67	144	26	12	
	250L10	3	10	4/6	25.3	643			33	15	
	250L15	5	15		34.4	873			44	20	
	250L20	7	20		43.4	1103			55	25	
	250L25	8	25	6	48.0	1218			60	27	
	250L30	9	30		52.5	1333			66	30	
	250L40	13	40		70.6	1793			88	40	
	250L50	16	50		84.2	2138			104	47	
250L60	19	60	97.8		2484	128	58				
320L	320L07**	2	7.5	4/6	21.8	553	5.67	144	27	12	
	320L15	4	15	4/6	30.8	783			38	17	
	320L20	5	20		35.4	898			45	20	
	320L25	6	25		39.9	1013			50	22	
	320L30	8	30	6	49.0	1243			61	27	
	320L40	11	40		62.5	1588			78	35	
	320L50	13	50		71.6	1818			89	40	
	320L60	16	60		84.2	2138			104	47	

* Note pump diameter - high pressure models have an exterior casing and larger diameters, verify they will fit your well.

** Pumps can be configured to accommodate a 4" or 6" motor. See product order code.

MOTOR DATA

NOTE: 4" diameter motors are required for 3 and 5 HP "L" Series pumps.
 4" or 6" diameter motors can be used for 7.5 HP "L" Series pumps. See Water End Data Chart.
 6" diameter motors are required for 10 HP and larger "L" Series pumps.

CENTRIPRO 4" MOTORS

Single Phase Motors - Dimensions and Weights					
Motor Order No.	HP	Motor Dia.	Volts	Length in. (mm)	Weight lbs. (Kg)
M30412	3	4"	230	18.3 (466)	40 (18.1)
M50412	5			27.7 (703)	70 (31.8)
Three Phase Motors - Dimensions and Weights					
M30430	3	4"	200	15.3 (389)	32 (14.5)
M30432			230		
M30434			460		
M50430	5	4"	200	21.7 (550)	55 (24.9)
M50432			230		
M50434			460		
M75430	7.5	4"	200	27.7 (703)	70 (31.8)
M75432			230		
M75434			460		

CENTRIPRO 6" MOTORS

Single Phase Motors - Dimensions and Weights					
Motor Order No.	HP	Motor Dia.	Volts	Length (inches)	Weight (lbs)
6M071	7.5	6"	230	29.9	128
6M101	10	6"	230		
6M151	15	6"	230	33.5	148
Three Phase Motors - Dimensions and Weights					
6M078	7.5	6"	200	24.8	99
6M072			230		
6M074			460		
6M108	10	6"	200	27.0	110
6M102			230		
6M104			460		
6M158	15	6"	200	29.9	128
6M152			230		
6M154			460		
6M208	20	6"	200	31.5	137
6M202			230		
6M204			460		
6M258	25	6"	200	36.2	161
6M252			230		
6M254			460		
6M308	30	6"	200	38.2	176
6M302			230		
6M304			460		
6M404	40	6" x 8"	460	40.6	187
66M504	50			41.7	198
86M504	50			46.4	353

CENTRIPRO FM-SERIES 6" MOTORS

Single Phase Motors Dimensions and Weights					
Motor Order No.	HP	Motor Dia.	Volts	Length (inches)	Weight (lbs)
6F051	5	6"	230	25.6	143
6F071	7.5			28.1	161
6F101	10			30.3	161
6F151	15			32.8	181
Three Phase Motors Dimensions and Weights					
Motor Order No.	HP	Motor Dia.	Volts	Length (inches)	Weight (lbs)
6F058	5	6"	200-208	23.0	107.0
6F052			230		
6F054			460		
6F078	7.5	6"	200-208	24.3	117.0
6F072			230		
6F074			460		
6F108	10	6"	200-208	25.6	124.0
6F102			230		
6F104			460		
6F158	15	6"	200-208	28.1	127.0
6F152			230		
6F154			460		
6F208	20	6"	200-208	30.3	152.0
6F202			230		
6F204			460		
6F258	25	6"	200-208	32.8	164.0
6F252			230		
6F254			460		
6F308	30	6"	200-208	35.6	185.0
6F302			230		
6F304			460		
6F404	40	6"	460	39.3	207.0
6F504	50		460	54.1	285.0

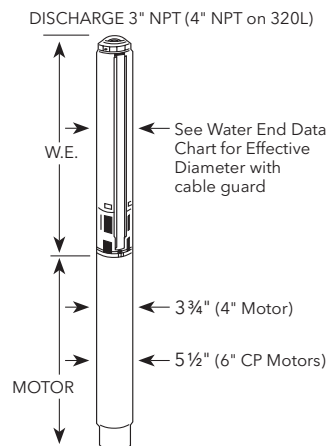

MODEL 50L

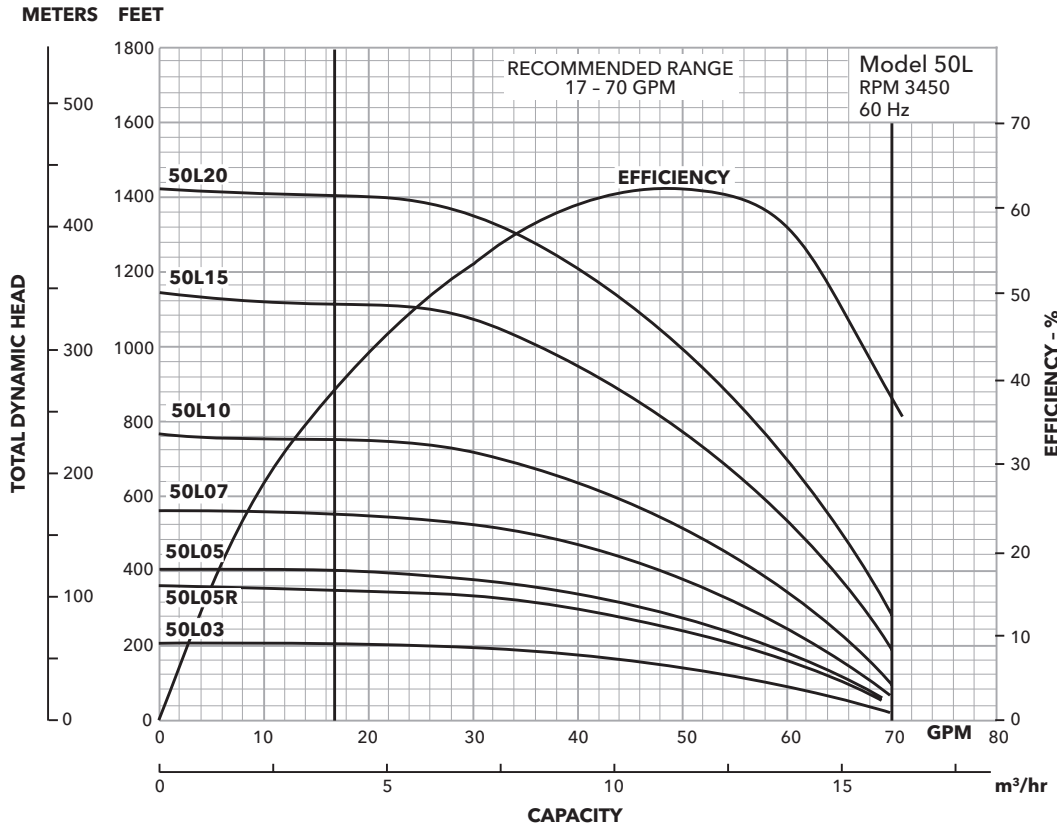

MODEL 65L

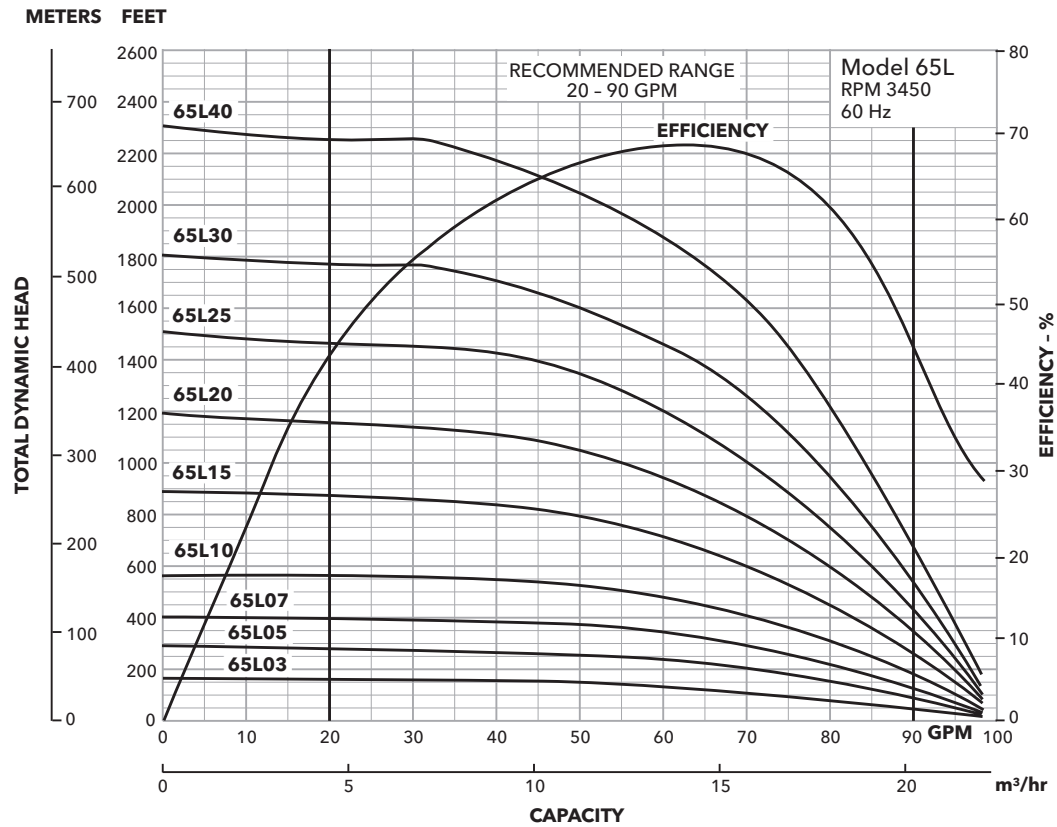

MODEL 95L

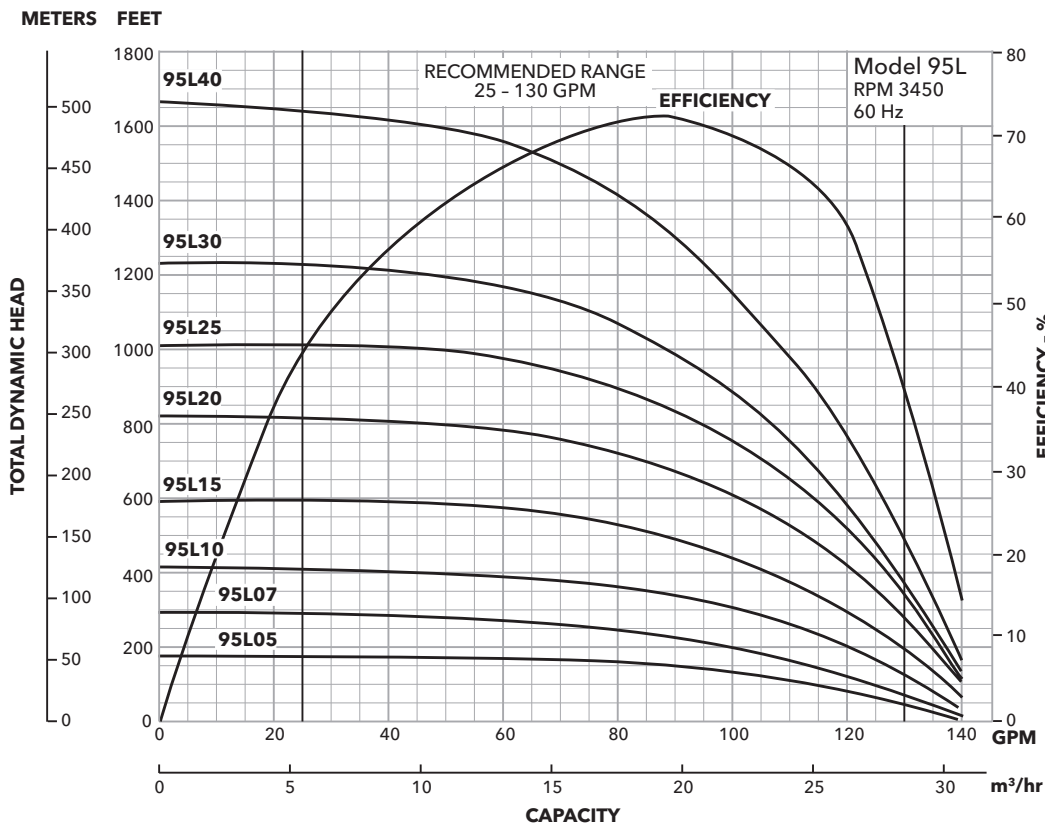

MODEL 120L

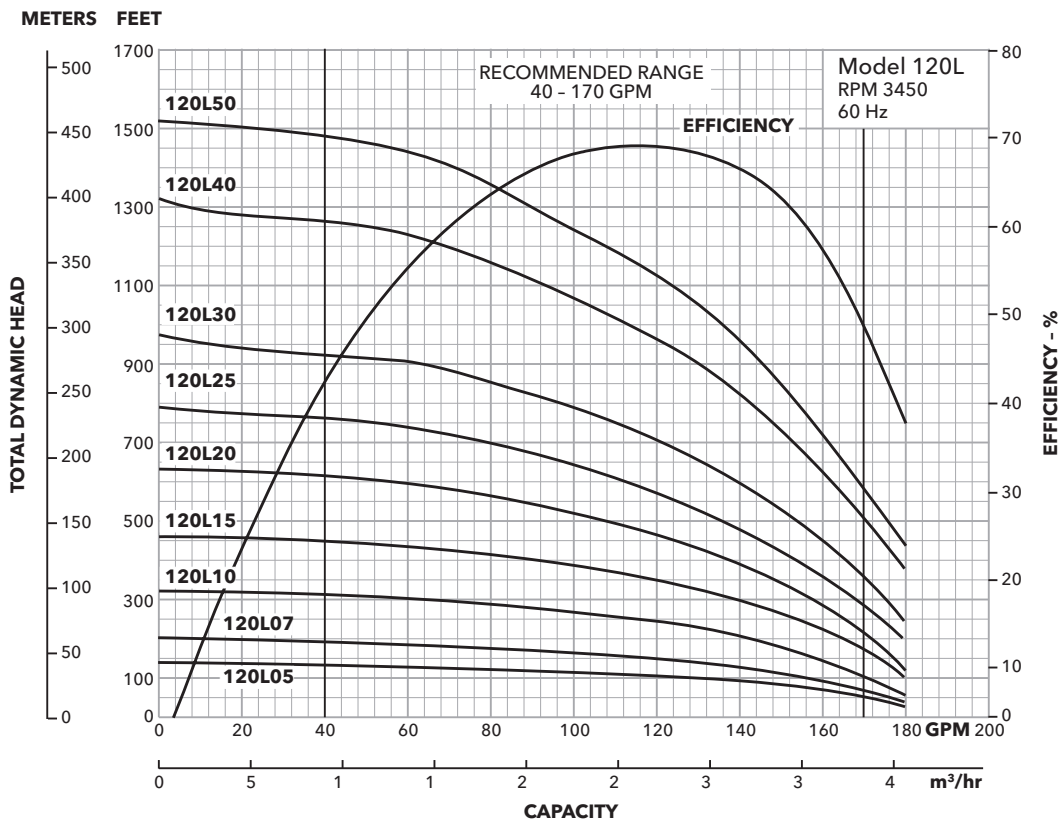

MODEL 160L

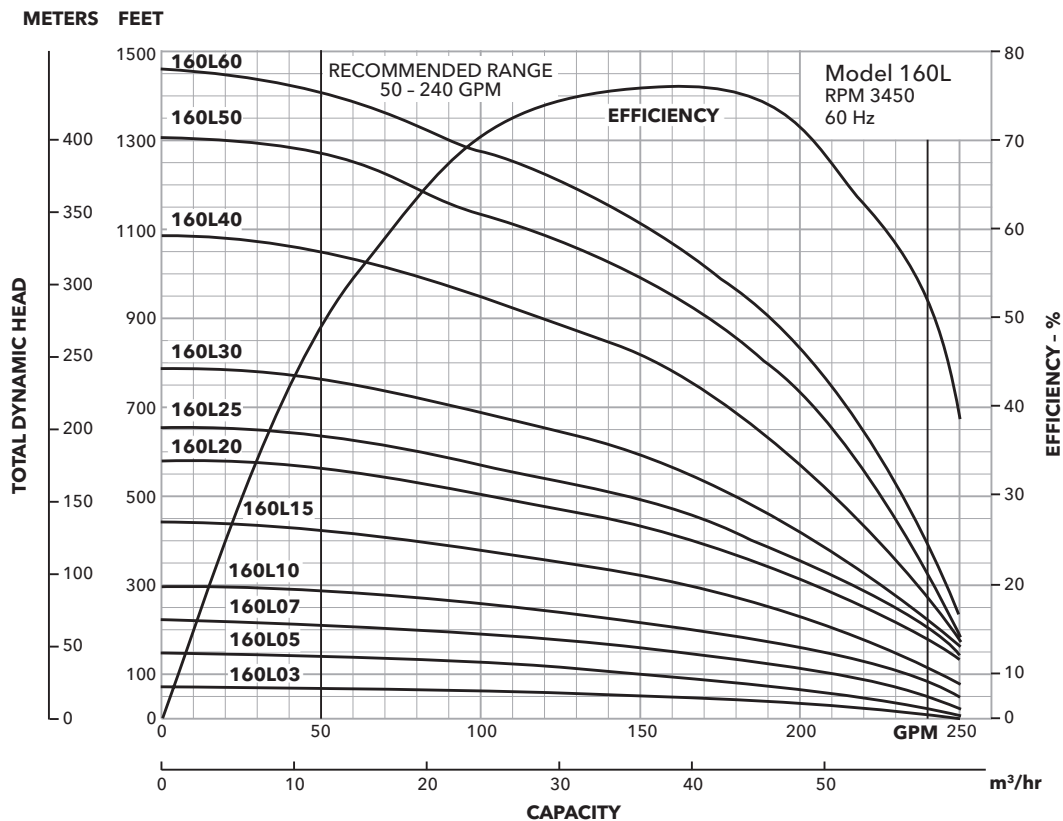

MODEL 250L

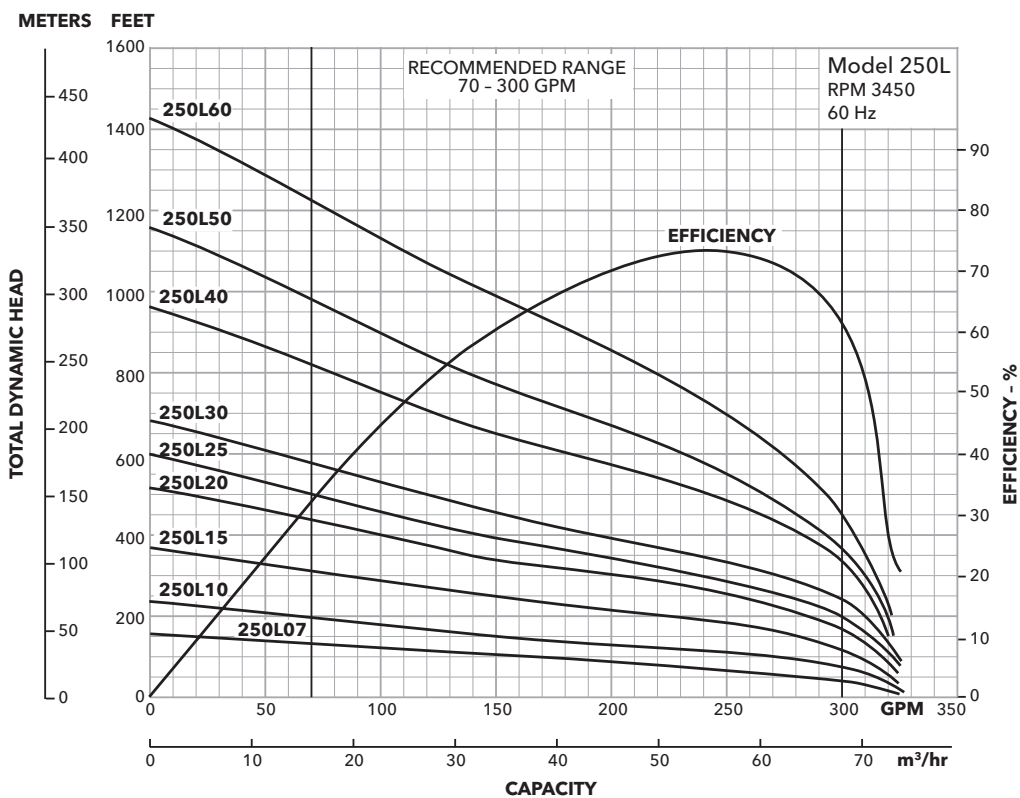

NOTE: On 250L, operation below minimum recommended flow will increase motor amp. draw and trip overloads.

MODEL 320L

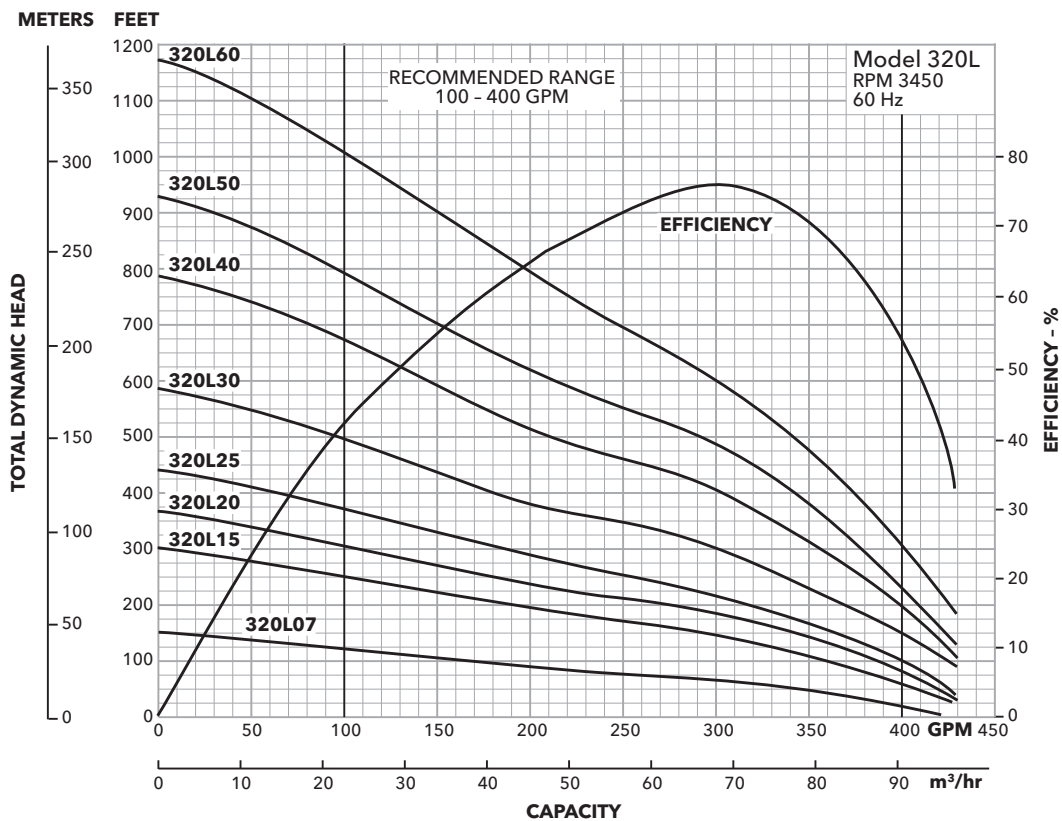

NOTE: On 320L, operation below minimum recommended flow will increase motor amp. draw and trip overloads.

MODEL 50L

SELECTION CHART

Horsepower Range 3 - 20, Recommended Range 17 - 70 GPM, 60 Hz, 3450 RPM

Pump Model	Depth to Water in Feet/Ratings in GPM (Gallons per Minute)																																						
	HP	PSI	25	50	75	100	125	150	175	200	225	250	275	300	325	350	375	400	425	450	475	500	525	550	575	600	625	650	675	700	725	750							
50L03 4 Stages	3	0		74	68	62	58	50	42	21																													
		20	69	63	59	52	43	27																															
		30	63	59	52	44	29																																
		40	59	53	45	31																																	
		50	53	45	33																																		
		60	46	35																																			
50L05R 7 Stages	5	0				56	72	67	62	59	58	54	48	44	40	27																							
		20		49	72	68	62	60	58	55	49	44	41	31																									
		30	45	71	69	63	60	58	55	50	45	41	32																										
		40	71	69	63	60	58	55	50	45	41	33																											
		50	70	63	60	58	56	51	45	42	34																												
		60	64	60	59	56	51	46	42	35																													
50L05 8 Stages	5	0				65	74	72	68	64	62	60	58	54	50	46	42	36	21																				
		20	62	73	72	68	65	62	61	58	55	51	47	43	37	24																							
		30	73	73	69	65	63	61	58	55	51	47	43	37	26																								
		40	73	69	65	63	61	59	56	52	47	43	38	27																									
		50	69	65	63	61	59	56	52	48	44	39	28																										
		60	66	63	61	59	56	52	48	44	39	29																											
50L07 11 Stages	7.5	0				63	72	74	72	68	66	64	62	61	59	57	55	52	49	46	43	39	33	21															
		20		60	72	74	72	69	66	64	62	61	60	58	55	52	49	46	43	40	34	23																	
		30	59	71	74	72	69	66	64	63	61	60	58	55	52	49	46	43	40	35	25																		
		40	71	74	72	69	66	64	63	61	60	58	56	53	50	47	44	40	35	26																			
		50	74	73	70	67	64	63	61	60	58	56	53	50	47	44	41	36	27																				
		60	73	70	67	65	63	61	60	58	56	53	50	47	44	41	36	27																					
50L10 15 Stages	10	0					57	68	73	74	73	71	68	66	65	63	62	61	60	59	57	56	54	51	49	47	45	43	40	36	30	21							
		20			54	67	72	74	73	71	69	67	65	63	62	61	60	59	58	56	54	52	49	47	45	43	40	37	32	23									
		30		53	66	72	74	73	71	69	67	65	64	62	61	60	59	58	56	54	52	50	47	45	43	41	37	32	24										
		40	52	65	72	74	73	71	69	67	65	64	63	62	61	59	58	56	54	52	50	48	45	43	41	38	33	24											
		50	65	72	74	73	71	69	67	65	64	63	62	61	59	58	56	54	52	50	48	46	43	41	38	33	25												
		60	71	74	73	72	69	67	65	64	63	62	61	60	58	56	55	52	50	48	46	44	41	38	33	26													

Pump Model	Depth to Water in Feet/Ratings in GPM (Gallons per Minute)																																						
	HP	PSI	50	100	150	200	250	300	350	400	450	500	550	600	650	700	750	800	850	900	950	1000	1050	1100	1150	1200	1250	1300	1350	1400	1450	1500							
50L15 23 Stages	15	0					63	72	74	72	68	66	64	62	61	59	57	55	52	49	46	43	39	33	21														
		20			62	72	74	72	69	66	64	62	61	59	57	55	52	49	46	43	39	34	22																
		30		50	68	74	73	70	67	65	63	62	60	59	56	54	51	48	45	41	37	29																	
		40	33	60	72	74	72	69	66	64	62	61	60	58	55	52	49	46	43	40	34	23																	
		50	48	67	73	73	71	68	65	63	62	60	59	57	54	51	48	45	42	38	30																		
		60	59	71	74	72	69	66	64	63	61	60	58	55	52	49	46	43	40	35	25																		
50L20 27 Stages	20	0					57	68	73	74	73	71	68	66	65	63	62	61	60	59	57	56	54	51	49	47	45	43	40	36	30	21							
		20				56	67	73	74	73	71	68	66	65	63	62	61	60	59	58	56	54	52	49	47	45	43	40	37	31	22								
		30			46	62	71	74	74	72	70	67	66	64	63	62	61	60	58	57	55	53	50	48	46	44	42	39	34	27									
		40			54	67	72	74	73	71	69	67	65	63	62	61	60	59	58	56	54	52	49	47	45	43	40	37	32	23									
		50		44	61	70	73	74	72	70	68	66	64	63	62	61	60	59	57	55	53	51	48	46	44	42	39	35	28										
		60	30	53	66	72	74	73	71	69	67	65	64	62	61	60	59	58	56	54	52	50	47	45	43	41	37	32	24										

MODEL 320L

SELECTION CHART

Horsepower Range 7.5 - 60, Recommended Range 100 - 400 GPM, 60 Hz, 3450 RPM

Pump Model	Depth to Water in Feet/Ratings in GPM (Gallons per Minute)																														
	HP	PSI	25	50	75	100	125	150	175	200	225	250	275	300	325	350	375	400	425	450	475	500	525	550	575	600	625	650			
320L07 2 Stages	7.5	0		343	262	172																									
		20	275	186																											
		30	193	100																											
		40	107																												
		50																													
		60																													
320L15 4 Stages	15	0		392	393	370	332	286	237	189	143																				
		20	394	374	338	293	245	196	150	105																					
		30	376	341	297	248	200	153	108																						
		40	344	300	252	204	157	112																							
		50	304	256	207	160	115																								
		60	260	211	164	119																									
320L20 5 Stages	20	0				391	365	336	303	267	228	188	147	105																	
		20		394	370	341	308	273	234	194	153	112																			
		30	396	372	343	311	275	237	197	156	115																				
		40	374	345	313	278	240	200	159	118																					
		50	348	316	281	243	203	162	121																						
		60	319	284	246	207	166	124																							
320L25 6 Stages	25	0					387	366	343	316	288	257	225	191	157	123															
		20				390	370	346	320	292	262	230	196	162	128																
		30		392	371	348	322	294	264	232	199	165	130																		
		40	393	373	350	324	296	266	235	201	167	133																			
		50	375	352	326	299	269	237	204	170	136	101																			
		60	354	328	301	271	239	206	173	138	104																				
320L30 8 Stages	30	0						391	375	357	336	314	291	267	242	217	192	166	141	116											
		20					393	378	360	340	318	295	271	246	221	196	170	145	120												
		30				395	379	361	341	319	296	273	248	223	197	172	147	122													
		40			396	380	363	343	321	298	274	250	225	199	174	149	124														
		50		397	382	364	344	323	300	276	252	227	201	176	151	125	100														
		60	398	383	365	346	324	302	278	254	229	203	178	153	127	102															
320L40 11 Stages	40	0									399	388	375	361	346	331	314	297	280	262	244	225	207	188	169	150	131	113			
		20									390	377	363	349	333	317	300	282	265	246	228	209	191	172	153	134	115				
		30									390	378	365	350	334	318	301	284	266	248	229	211	192	173	155	136	117				
		40									391	379	366	351	336	319	302	285	267	249	231	212	194	175	156	137	118				
		50									392	380	367	352	337	321	304	286	269	251	232	214	195	176	158	139	120	101			
		60									393	381	368	353	338	322	305	288	270	252	234	215	196	178	159	140	121	102			

Pump Model	Depth to Water in Feet/Ratings in GPM (Gallons per Minute)																												
	HP	PSI	200	225	250	275	300	325	350	375	400	425	450	475	500	525	550	575	600	625	650	675	700	725	750	775			
320L50 13 Stages	50	0					395	387	378	367	355	343	330	316	301	286	270	254	238	222	205	188	172	155	138	122	106		
		20		396	388	379	369	357	345	332	318	303	288	273	257	241	224	208	191	174	158	141	124	108	146	135			
		30	397	389	380	369	358	346	333	319	304	289	274	258	242	225	209	192	176	159	142	126	109	147	136	125			
		40	390	381	370	359	347	334	320	306	291	275	259	243	227	210	193	177	160	143	127	111							
		50	381	371	360	348	335	321	307	292	276	260	244	228	211	195	178	161	145	128	112								
		60	372	361	349	336	322	308	293	277	262	246	229	213	196	179	163	146	129	113									

Pump Model	Depth to Water in Feet/Ratings in GPM (Gallons per Minute)																																		
	HP	PSI	200	225	250	275	300	325	350	375	400	425	450	475	500	525	550	575	600	625	650	675	700	725	750	775	800	825	850	875	900	925	950	975	1000
320L60 16 Stages	60	0							395	389	383	376	368	360	351	341	331	320	308	295	281	268	253	239	224	209	195	181	167	154	142	130	120	109	100
		20					396	390	384	377	369	361	352	343	332	321	309	297	284	270	255	241	226	212	197	183	169	156	144	132	121	111	101		
		30					397	391	384	377	370	362	353	344	333	322	310	298	285	271	257	242	227	213	198	184	170	157	145	133	122	112	102		
		40					397	391	385	378	370	362	354	344	334	323	311	299	286	272	258	243	228	214	199	185	171	158	146	134	123	112	103		
		50		398	391	385	378	371	363	354	345	335	324	312	300	287	273	259	244	230	215	200	186	172	159	146	135	124	113	103					
		60	398	392	386	379	372	364	355	346	336	325	313	301	288	274	260	245	231	216	201	187	173	160	147	136	124	114	104						



Xylem Inc.
 2881 East Bayard Street Ext., Suite A
 Seneca Falls, NY 13148
 Phone: (800) 453-6777
 Fax: (888) 322-5877
www.gouldswatertechnology.com

Goulds is a registered trademark of Goulds Pumps, Inc. and is used under license.
 CentriPro and Aquavar SOLO are trademarks of Xylem Inc. or one of its subsidiaries.
 © 2016 Xylem Inc. B50-320L R7 April 2016