

LIQUID-SPECIFIC PRODUCT LINE: REFRIGERATION AMMONIA

SERIES 4924A (REPLACED SERIES 4925)

Section	420
Page	420.1
Issue	E

SERIES DESCRIPTION

Viking's 4924A Series Positive Displacement (PD) pumps offer safety, reliability and high efficiency in refrigeration ammonia recirculation applications. Safety is achieved through use of a double mechanical dynamic shaft seal located between bearings for minimum possible shaft run-out, with a pressurized barrier fluid system, and O-ring type static seals where components are joined. Reliability is provided by slow speed operation and low differential pressures, which maximize bearing and seal life. And efficiency is inherent in the PD Internal Gear pumping principle, compared to centrifugal pumps. Viking pumps can usually use at least one motor size smaller than these technologies.



HL4924A

OPERATING RANGE:

Nominal Flow	GPM	10 to 60
	m ³ /h	2.3 to 13.6
Maximum Pressure	PSI	to 50
	Bar	to 3.5
Temp. Range	°F	-40 to +225
	°C	-40 to +107

NOMINAL FLOW RATES:

Pump Size	GPM	LPM	RPM
HL	10	37.8	780
K	20	75.7	280
KK	30	113.5	280
LQ	45	170	280
LL	60	227	280

PUMPING PRINCIPLE

The internal Gear Positive Displacement pumping principle provides very low NPSH required, to minimize potential for flashing or cavitation. The shaft turns the rotor gear, which then turns the idler gear (mounted on the idler pin in the head). As they rotate, they create fluid cavities filled by ammonia on the suction side, then collapse those cavities to force liquid out on the discharge side. Carbon graphite shaft and idler bushings provide excellent low-viscosity gear/shaft support.

END CLEARANCE ADJUSTMENT

The 4924A series replaced Viking's old 4925 Series Ammonia pumps. The key difference is the bearing housing on the bracket simplifies adjusting end clearance, which helps ensure optimal efficiency and can compensate for wear over time. With this design, you simply rotate the bearing housing clockwise until it stops, then back it off the distance recommended in the Technical Service Manual (TSM 420.1) to set the end clearance, and lock it down. The old style required rotating two bearing end caps and measuring end clearance with a feeler gauge, which required removal from service.

Section	420
Page	420.2
Issue	E

LIQUID-SPECIFIC PRODUCT LINE: REFRIGERATION AMMONIA SERIES 4924A (REPLACED SERIES 4925)

DOUBLE DYNAMIC SEALING

The double mechanical seals provide carbon graphite rotating faces against Ni-Resist stationary seats. Ni-Resist is a metallic face which can be replaced without concern for hairline cracks that can occur when installing ceramic or silicon carbide seals, another safety feature. The area between the inboard and outboard mechanical seals is filled with refrigeration oil supplied by a reservoir mounted above the pump. A unique flush line with valve carries ammonia from behind the rotor to the reservoir, pressurizing the barrier oil to the same pressure seen by the seal inside the pump. The outboard seal sees only oil, and provides a secondary barrier should the inboard seal begin to leak.

The reservoir may be filled with oil using a port on the top, or, an optional filling valve on the side of the pump permits refilling during pump operation. A sight glass allows visual inspection of oil level.

The benefit of double mechanical seals versus sealless magnetic drives is that it is inherently more efficient, requiring less power, because mag drive pumps require recirculation (slip) through the canister area to remove heat generated by eddy currents.

PRESSURE RELIEF

Positive displacement pumps must be fitted with a pressure relief device to prevent overpressure. Viking's 4924A Series pumps are supplied with a Return-To-Tank (RTT) Pressure Relief Valve (PRV) as standard, which routes ammonia from any overpressure situation back to the tank.

MODEL NUMBER KEY

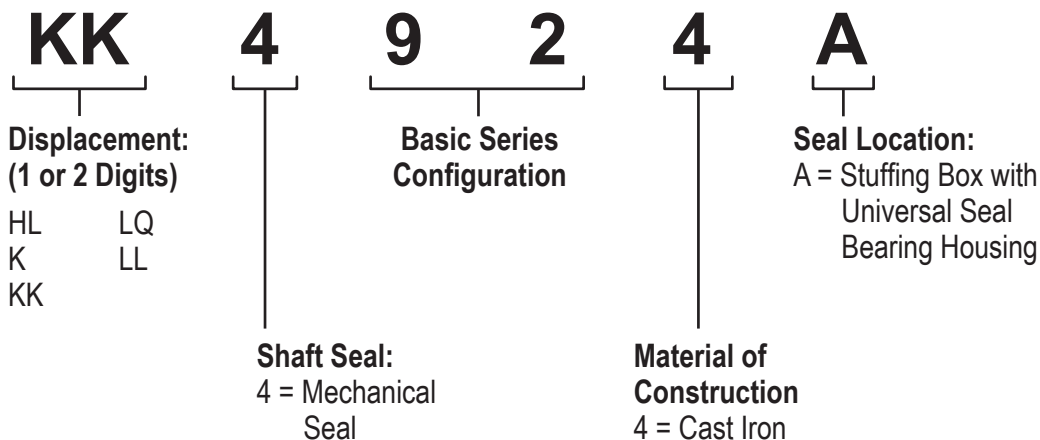

OPTIONAL FEATURES

(Specify these special features when ordering)

① Sight Glass with Frost Shield.
This prevents the sight glass from being covered with frost when the pumping unit is installed in a cold room.

② Filling Valve.
A filling valve can be furnished to permit easy refilling of oil reservoir without stopping pump.

③ Oil Reservoir Heater.
(Not Illustrated) An electric immersion type heater to provide adequate reservoir oil temperature if pumping unit is installed in a cold room.

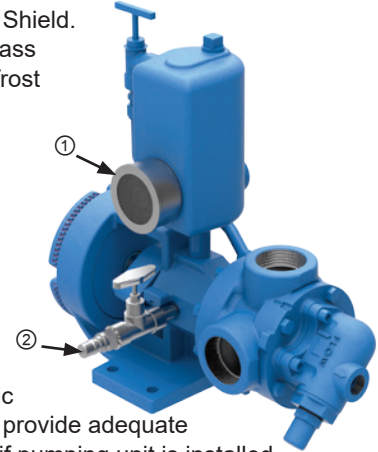

**LIQUID-SPECIFIC PRODUCT LINE:
REFRIGERATION AMMONIA
SERIES 4924A (REPLACED SERIES 4925)**

Section	420
Page	420.3
Issue	E

FEATURES & BENEFITS

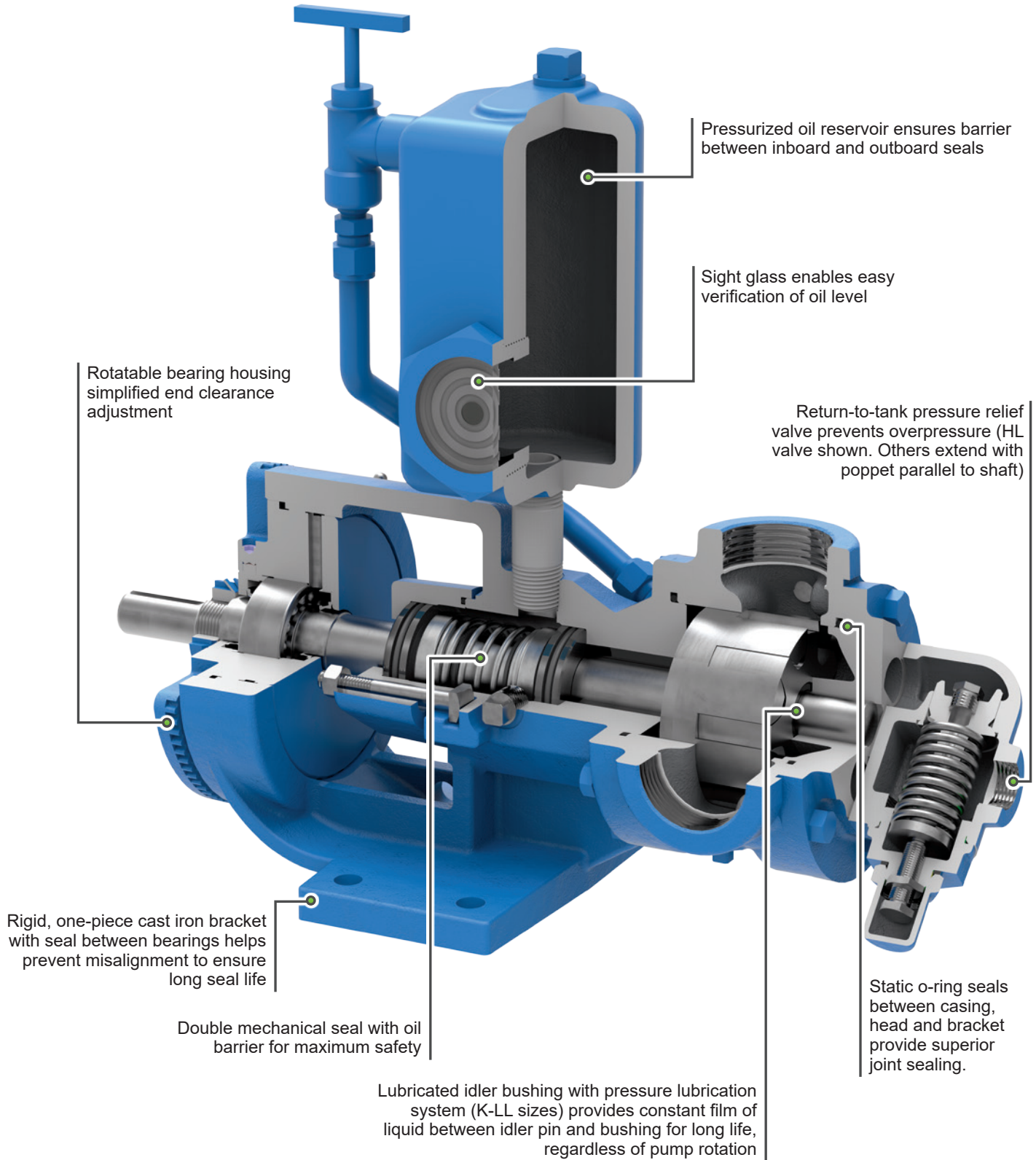

Section	420
Page	420.4
Issue	E

**LIQUID-SPECIFIC PRODUCT LINE:
REFRIGERATION AMMONIA
SERIES 4924A (REPLACED SERIES 4925)**

MATERIALS OF CONSTRUCTION

Component	Standard Material
Casing, Head and Bracket	Cast Iron ASTM A48, Class 35B
Rotor	Cast Iron, ASTM A48, Class 35B
Shaft	Steel, ASTM A108, Grade 1045
Idler ①	Cast Iron, ASTM A48, Class 35B
Idler Pin	Hardened Steel, ASTM A108 Grade 10L45
Bracket Bushing	Carbon Graphite
Idler Bushing	Carbon Graphite
Double Mechanical Seal	Carbon vs. Ni-Resist Faces, Neoprene Elastomers
Static O-Ring Seals	Buna
Return-to-Tank Relief Valve	Cast Iron ASTM A48, Class 35B

SPECIFICATIONS

Footed Model	Standard Port Sizes ②	Nominal Capacity		Maximum Speed	Maximum Differential Pressure		Minimum Temperature for Catalog Pump ④		Approximate Shipping Weight with PRV & Reservoir	
	Inches	GPM	LPM	RPM	PSIG	Bar	°F	°C	Lbs	Kg.
HL4924A	1.5	10	37.8	780	50	3.5	-20	-29	70	32
K4924A	2	20	75.7	280	50	3.5	-20	-29	135	62
KK4924A	2	30	113.5	280	50	3.5	-20	-29	140	64
LQ4924A	2.5 ③	45	170	280	50	3.5	-20	-29	215	98
LL4924A	3 ③	60	227	280	50	3.5	-20	-29	230	105

① HL size cast iron idler is lubrite coated.

② Suction piping recommended one size larger than pump suction port.

③ ANSI compatible Class 125 Flanged Ports, furnished with NPT companion flanges. All other models NPT ports.

④ Pumps can be used to -40°F (-40°C) if provision is made to provide heat to oil in seal chamber.

**LIQUID-SPECIFIC PRODUCT LINE:
REFRIGERATION AMMONIA**

SERIES 4924A (REPLACED SERIES 4925)

Section	420
Page	420.5
Issue	E

DIMENSIONS – HL, K, KK, LQ & LL SIZES (UNMOUNTED PUMPS)

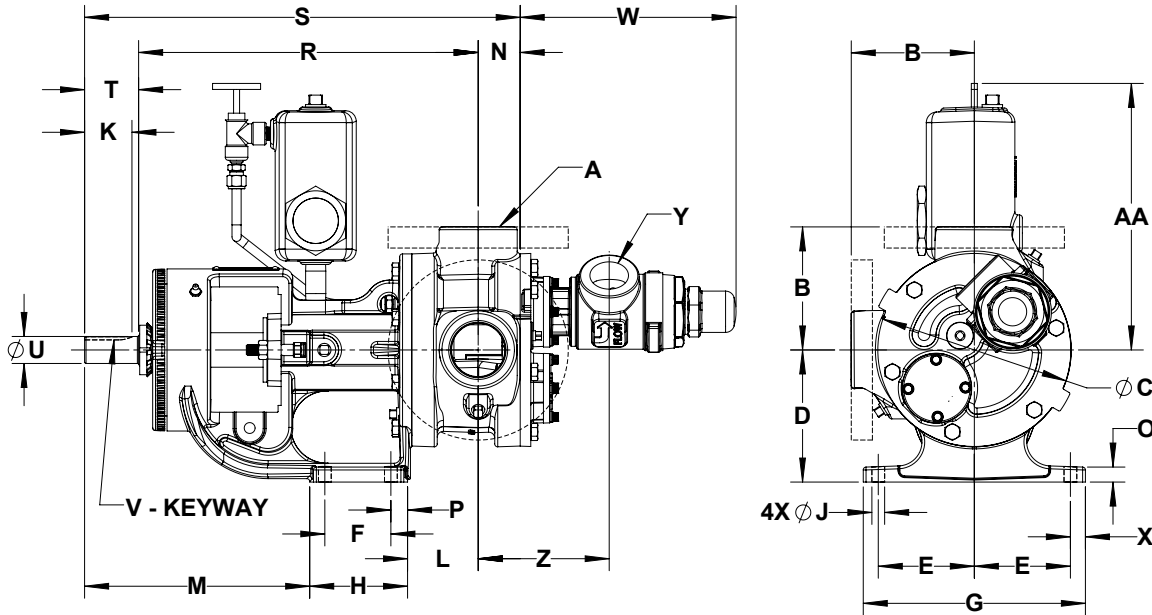

SIZE		A	B	C	D	E	F	G	H	J	K	L	M	N	O	P	R	S	T	U	V	W ^①	X	Y	Z	AA
HL	in	1.5	3.00	4.79	3.50	2.75	2.25	6.75	3.74	0.47	0.99	3.26	5.07	1.19	0.56	0.75	10.44	13.26	1.63	0.75	.19 x .09	3.10	0.63	0.50	0.00	10.79
	mm		76.2	121.7	88.9	69.9	57.2	171.5	95.0	11.9	25.1	82.8	128.8	30.2	14.2	19.1	265.2	336.8	41.4	19.1	4.83 x 2.29	78.7	16.0	12.7	0.0	274.1
K KK	in	2	5.12	8.06	5.50	4.00	2.75	9.25	4.08	0.53	1.42	2.94	9.37	1.75	0.62	0.70	14.14	18.14	2.25	1.12	.25 x .12	8.99	0.63	1.25	5.46	11.10
	mm		130.0	204.7	139.7	101.6	69.9	235.0	103.6	13.5	36.1	74.7	238.0	44.5	15.7	17.8	359.2	460.8	57.2	28.4	6.35 x 3.05	228.3	16.0	31.8	138.7	281.9
LQ	in	2.5	7.19	10.40	7.00	4.38	4.00	10.00	5.47	0.53	1.42	3.50	9.03	1.75	0.62	0.63	15.63	19.63	2.25	1.12	.25 x .12	9.03	0.63	1.50	5.32	10.75
	mm		182.6	264.2	177.8	111.3	101.6	254.0	138.9	13.5	36.1	88.9	229.4	44.5	15.7	16.0	397.0	498.6	57.2	28.4	6.35 x 3.05	229.4	16.0	38.1	135.1	273.1
LL	in	3	7.19	10.40	7.00	4.38	4.00	10.00	5.47	0.53	1.42	3.50	9.03	2.25	0.62	0.63	15.63	20.12	2.25	1.12	.25 x .12	9.03	0.63	1.50	6.00	10.75
	mm		182.6	264.2	177.8	111.3	101.6	254.0	138.9	13.5	36.1	88.9	229.4	57.2	15.7	16.0	397.0	511.0	57.2	28.4	6.35 x 3.05	229.4	16.0	38.1	152.4	273.1

① HL valve poppet perpendicular to shaft. See page 420.3 for example.

Section	420
Page	420.6
Issue	E

**LIQUID-SPECIFIC PRODUCT LINE:
REFRIGERATION AMMONIA
SERIES 4924A (REPLACED SERIES 4925)**

PERFORMANCE CURVE NOTES

Performance Curves:

Ammonia pump performance curves are not shown on the Pump Selector on www.vikingpump.com. Use the performance curves on the following pages.

NPSH (Net Positive Suction Head):

The NPSH_R (Net Positive Suction Head Required by the pump) of the Viking Series 4924A Refrigeration Ammonia pumps is a minimum of 4'. An NPSH_A (Net Positive Suction Head – Available in the system) of more than 4' is desirable for smooth, trouble-free operation particularly at maximum speeds and/or at temperatures below -20°F (-29°C).

For a complete explanation of NPSH, refer to Viking Application Data Sheet AD-19.

The schematic at right depicts a typical accumulator, piping and pump arrangement.

SUCTION LINE SIZE:

It is recommended that the suction line size be one pipe size larger than the pump port.

INSULATION:

The suction line from the accumulator must be well insulated so that the heat pickup is held to a minimum.

REFERENCE:

Refer to Viking Application Data Sheet AD-2 and Viking Technical Service Manual TSM 420.1 for more detailed information on liquid ammonia applications.

MECHANICAL EFFICIENCY:

The Mechanical Efficiency (expressed in percent) can be calculated using the following formula:

$$\text{Mechanical Efficiency} = \frac{\text{Differential Pressure, PSI} (\text{Capacity, GPM}) (100)}{\text{(Horsepower, BHP)} (1715)}$$

METRIC CONVERSION:

The following table has been compiled for conversion to metric values.

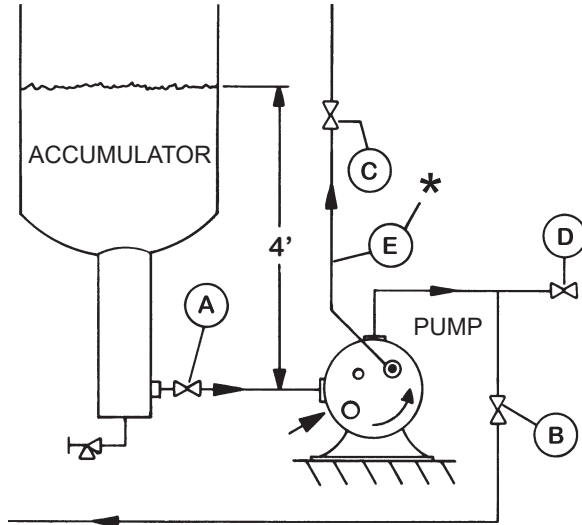

Schematic of Piping and Valves for a Liquid Ammonia Recirculating Pump in a Refrigeration System

*This segment of line ㉔ between the return-to-tank pressure relief valve and the shutoff valve ㉔ should include a pressure relief valve vented to a safe area.

LEGEND:

- Ⓐ Inlet (suction) side shutoff valve
- Ⓑ Discharge side shutoff valve
- Ⓒ Shutoff valve in return line from the relief valve to the accumulator
- Ⓓ Vent (purge or bleed) valve
- Ⓔ Return line from pump mounted return-to-tank pressure relief valve to the accumulator

VACUUM		PRESSURE		CAPACITY	
In - Hg (Inches of Mercury)	kPa* (Kilopascals)	PSI (lb / in ²)	kPa* (Kilopascals)	GPM (US Gal / Minute)	L / min (Liter / Minute)
1	3.4	1	6.9	1	3.8
5	17	25	172	0.26	1
10	34	50	345	---	---
15	51	100	690	---	---
20	68	150	1034	---	---
25	85	200	1379	---	---
---	---	250	1724	---	---

* 100 kPa = 1 bar

LIQUID-SPECIFIC PRODUCT LINE: REFRIGERATION AMMONIA

SERIES 4924A (REPLACED SERIES 4925)

Section	420
Page	420.7
Issue	E

PERFORMANCE CURVES – HL, K, KK, LQ SIZES

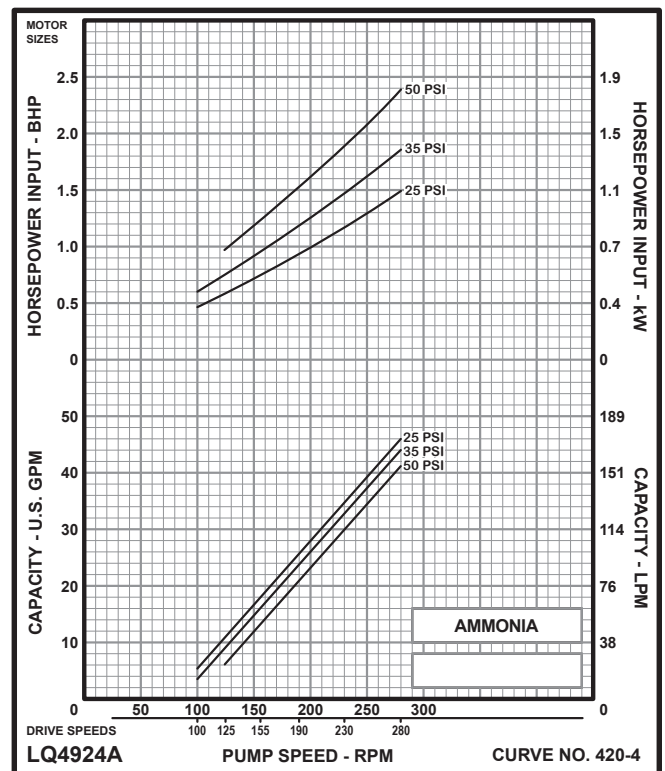
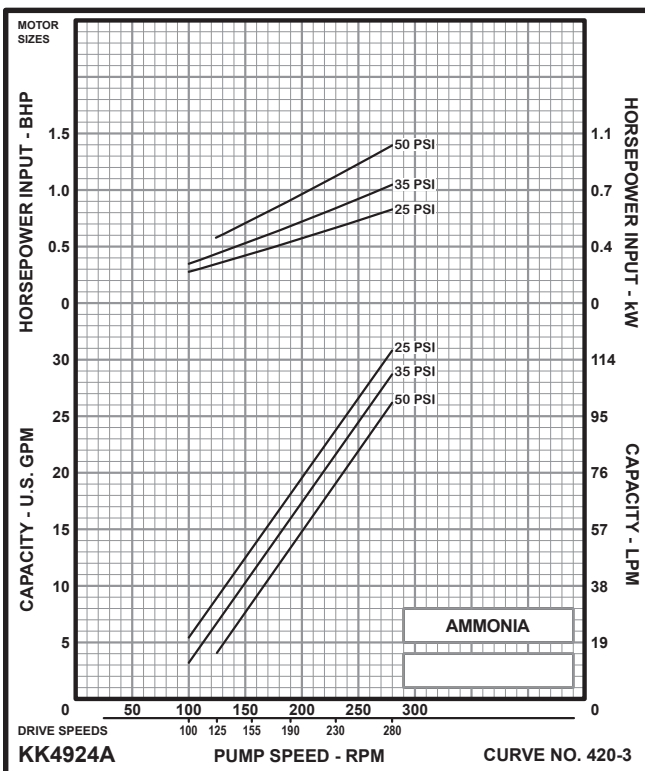
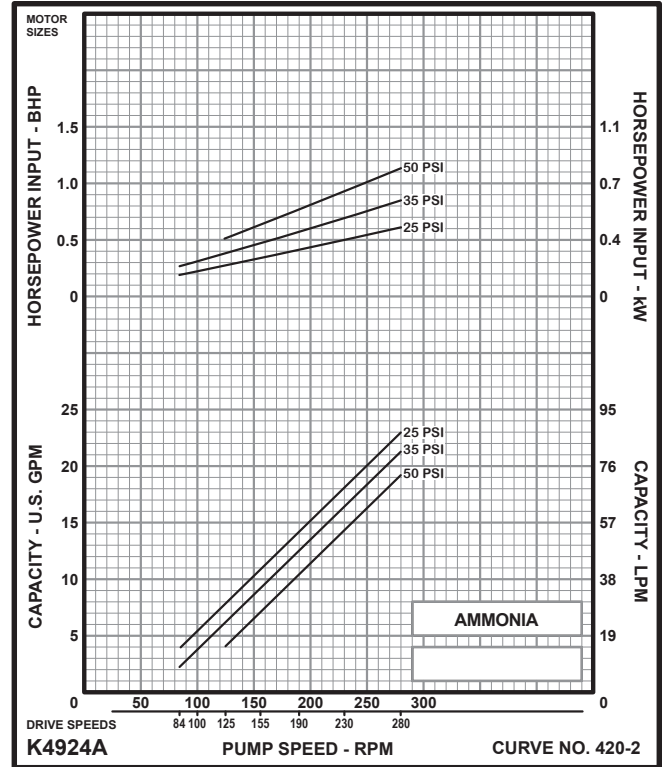
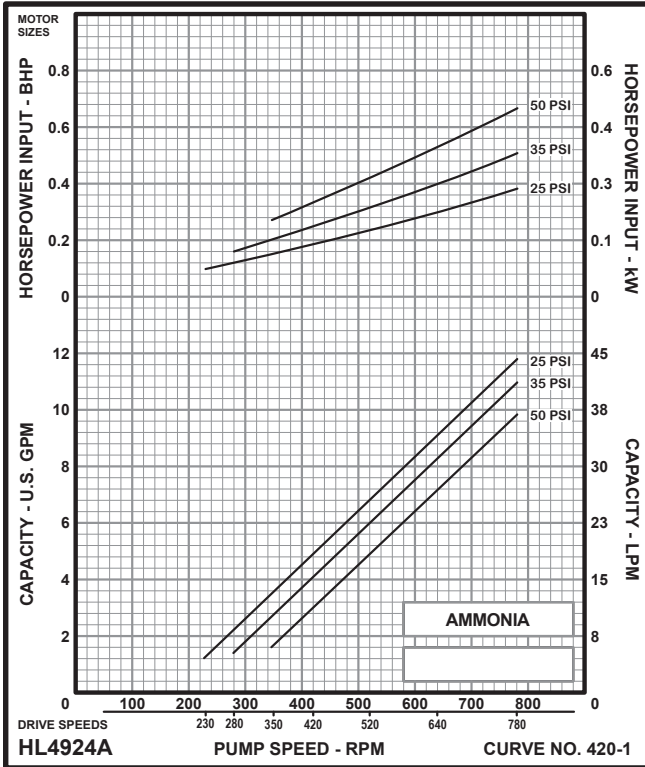

Section	420
Page	420.8
Issue	E

**LIQUID-SPECIFIC PRODUCT LINE:
REFRIGERATION AMMONIA
SERIES 4924A (REPLACED SERIES 4925)**

PERFORMANCE CURVES – LL SIZE

